

Czech Republic



National Report *under the* *Convention on Nuclear Safety*



Revised 2007

Table of Contents

INTRODUCTION	- 7 -
LIST OF ABBREVIATIONS	- 8 -
1. EXISTING NUCLEAR INSTALLATIONS - ARTICLE 6 OF THE CONVENTION	- 11 -
1.1 DESCRIPTION OF THE CURRENT SITUATION	- 11 -
1.1.1 Existing nuclear installations in the Czech Republic as defined in Article 2 of the Convention.....	- 11 -
1.1.2 Dukovany NPP.....	- 11 -
1.1.3 Temelín NPP	- 14 -
1.2 STATEMENT ON THE IMPLEMENTATION OF THE OBLIGATIONS CONCERNING ARTICLE 6 OF THE CONVENTION – POSITION OF THE CZECH REPUBLIC ON THE CURRENT STATUS OF NUCLEAR SAFETY AND FUTURE OPERATION OF THE NUCLEAR INSTALLATIONS	- 18 -
2. LEGISLATIVE AND REGULATORY FRAMEWORK – ART. 7 OF THE CONVENTION	- 20 -
2.1 DESCRIPTION OF THE CURRENT SITUATION	- 20 -
2.1.1 Development of national legislative and regulatory framework.....	- 20 -
2.1.2 Valid legislation in the area of utilization of nuclear energy and ionizing radiation.....	- 20 -
2.1.3 Multilateral international treaties and treaties with IAEA	- 23 -
2.1.4 WENRA	- 23 -
2.2 STATEMENT ON THE IMPLEMENTATION OF THE OBLIGATIONS CONCERNING ARTICLE 7 OF THE CONVENTION.....	- 25 -
3. REGULATORY BODY - ARTICLE 8 OF THE CONVENTION	- 26 -
3.1 DESCRIPTION OF THE CURRENT SITUATION	- 26 -
3.1.1 Mandate and competence of the regulatory body.....	- 26 -
3.1.2 Rights and responsibilities of the regulatory body	- 28 -
3.1.3 Position of the regulatory body within the state administration structure.....	- 30 -
3.1.4 Structure of the regulatory body, its technical support, material and human resources.....	- 30 -
3.1.5 Relations between the regulatory body other state administration bodies	- 31 -
3.1.6 Independent assessments of the national regulatory body.....	- 31 -
3.2 STATEMENT ON THE IMPLEMENTATION OF THE OBLIGATIONS CONCERNING ARTICLE 8 OF THE CONVENTION.....	- 32 -
4. RESPONSIBILITIES OF THE LICENSEE - ARTICLE 9 OF THE CONVENTION	- 35 -
4.1 DESCRIPTION OF THE CURRENT SITUATION	- 35 -
4.2 STATEMENT ON THE IMPLEMENTATION OF THE OBLIGATIONS CONCERNING ARTICLE 9 OF THE CONVENTION.....	- 36 -
5. PRIORITY TO SAFETY - ARTICLE 10 OF THE CONVENTION	- 37 -

5.1	DESCRIPTION OF THE CURRENT SITUATION	- 37 -
5.1.1	<i>Principle of priority to nuclear safety in the Czech legislation</i>	- 37 -
5.1.2	<i>Implementation of principles established in the legislation</i>	- 37 -
5.2	STATEMENT ON THE IMPLEMENTATION OF THE OBLIGATIONS CONCERNING ARTICLE 10 OF THE CONVENTION.....	- 40 -
6.	FINANCIAL AND HUMAN RESOURCES - ARTICLE 11 OF THE CONVENTION.....	- 41 -
6.1	DESCRIPTION OF THE CURRENT SITUATION	- 41 -
6.1.1	<i>Financial provision of nuclear safety enhancement at nuclear installations in the course of their operation</i>	- 41 -
6.1.2	<i>Provisions for assurance of financial and human resources for the decommissioning of nuclear installations and management of radioactive waste generated during their operation</i>	- 41 -
6.1.3	<i>Rules, regulations and provision of resources for qualification, basic training and regular training (including simulator training) of the personnel whose activities have impact on nuclear power installations safety</i>	- 43 -
6.2	STATEMENT ON THE IMPLEMENTATION OF THE OBLIGATIONS CONCERNING ARTICLE 11 OF THE CONVENTION.....	- 48 -
7.	HUMAN FACTORS - ARTICLE 12 OF THE CONVENTION	- 49 -
7.1	DESCRIPTION OF THE CURRENT SITUATION	- 49 -
7.1.1	<i>Methods for prevention, determination and correction of human errors</i>	- 49 -
7.1.2	<i>Role of the regulatory body in the human factor assessment</i>	- 50 -
7.2	STATEMENT ON THE IMPLEMENTATION OF THE OBLIGATIONS CONCERNING ARTICLE 12 OF THE CONVENTION.....	- 51 -
8.	QUALITY ASSURANCE - ARTICLE 13 OF THE CONVENTION.....	- 52 -
8.1	DESCRIPTION OF THE CURRENT SITUATION	- 52 -
8.1.1	<i>Quality assurance legislation</i>	- 52 -
8.1.2	<i>Quality assurance strategy of the licensee - ČEZ, a. s.</i>	- 52 -
8.1.3	<i>Quality assurance programs for all nuclear installation service life stages</i>	- 54 -
8.1.4	<i>Application and evaluation of quality assurance programs efficiency</i>	- 55 -
8.1.5	<i>Current quality assurance practices applied by the state regulatory body</i>	- 56 -
8.2	STATEMENT ON THE IMPLEMENTATION OF THE OBLIGATIONS CONCERNING ARTICLE 13 OF THE CONVENTION.....	- 57 -
9.	SAFETY ASSESSMENT AND VERIFICATION - ARTICLE 14 OF THE CONVENTION	- 58 -
9.1	DESCRIPTION OF THE CURRENT SITUATION	- 58 -
9.1.2	<i>Continual monitoring and periodic assessment of nuclear and technical safety at nuclear installations</i>	- 60 -
9.1.3	<i>Preventive maintenance, in-service inspections of main components, evaluation of ageing</i>	- 66 -
9.1.4	<i>Regulatory practice</i>	- 69 -
9.2	STATEMENT ON THE IMPLEMENTATION OF THE OBLIGATIONS CONCERNING ARTICLE 14 OF THE CONVENTION.....	- 70 -
10.	RADIATION PROTECTION – ARTICLE 15 OF THE CONVENTION	- 71 -
10.1	DESCRIPTION OF THE CURRENT SITUATION	- 71 -

10.1.1	Summary of legislation relating to radiation protection.....	- 71 -
10.1.2	Implementation of radiation protection requirements	- 74 -
10.1.3	Supervisory activities.....	- 77 -
10.2	STATEMENT ON THE IMPLEMENTATION OF THE OBLIGATIONS CONCERNING ARTICLE 15 OF THE CONVENTION.....	- 78 -
11.	EMERGENCY PREPAREDNESS - ARTICLE 16 OF THE CONVENTION.....	- 79 -
11.1	DESCRIPTION OF THE CURRENT SITUATION	- 79 -
11.1.1	Summary of national legislation for on-site and off-site emergency preparedness	- 79 -
11.1.2	Implementation of emergency preparedness measures, including role of the State Supervision Body and other departments	- 85 -
11.1.3	Training and exercise	- 95 -
11.2	STATEMENT ON THE IMPLEMENTATION OF THE OBLIGATIONS CONCERNING ARTICLE 16 OF THE CONVENTION.....	- 97 -
12.	SITING - ARTICLE 17 OF THE CONVENTION.....	- 98 -
12.1	DESCRIPTION OF THE CURRENT SITUATION	- 98 -
12.1.1	Description of the licensing process, including a summary of national legislation	- 98 -
12.1.2	Measures for fulfillment of the siting criteria for nuclear installation	- 100 -
12.1.3	Activities leading to the preliminary assessment of nuclear energy installations siting.....	- 106 -
12.1.4	Assessment of environmental impact of a nuclear power plant.....	- 106 -
12.1.5	International agreements with neighboring countries.....	- 107 -
12.2	STATEMENT ON THE IMPLEMENTATION OF THE OBLIGATIONS CONCERNING ARTICLE 17 OF THE CONVENTION.....	- 108 -
13.	DESIGN AND CONSTRUCTION - ARTICLE 18 OF THE CONVENTION	- 109 -
13.1	DESCRIPTION OF THE CURRENT SITUATION	- 109 -
13.1.1	Description of the licensing process including a summary of the national legislation.....	- 109 -
13.1.2	Dukovany NPP.....	- 110 -
13.1.3	Temelín NPP.....	- 112 -
13.2	STATEMENT ON THE IMPLEMENTATION OF THE OBLIGATIONS CONCERNING ARTICLE 18 OF THE CONVENTION.....	- 114 -
14.	OPERATION - ARTICLE 19 OF THE CONVENTION	- 115 -
14.1	DESCRIPTION OF THE CURRENT SITUATION	- 115 -
14.1.1	Description of licensing process, including summary of national legislation	- 115 -
14.1.2	Limits and Conditions for safe operation	- 118 -
14.1.3	Operation, maintenance, inspections and tests of nuclear installation	- 120 -
14.1.4	Intervention procedures for the anticipated operational events and accidents.....	- 124 -
14.1.5	Engineering and technical support.....	- 126 -
14.1.6	Operational events experience exploiting in ČEZ, a. s. NPPs.....	- 127 -
14.1.7	Notification of events important for nuclear safety.....	- 129 -
14.1.8	Optimization of nuclear installation operational radioactive waste production	- 130 -
14.2	STATEMENT ON THE IMPLEMENTATION OF THE OBLIGATIONS CONCERNING ARTICLE 19 OF THE CONVENTION.....	- 131 -
	A N N E X E S	- 133 -

Introduction

This Report is the National Report of the Czech Republic prepared for the purposes of a review by the parties to the Convention on Nuclear Safety. This Report has been elaborated with the objective to describe fulfillment of obligations arising from the Convention by the Czech Republic by June 30, 2007. The structure of the National Report is based on recommendations approved at the preparatory meeting of parties to the Convention in September 1995 and published as "Guidelines Regarding National Reports under the Convention on Nuclear Safety".

By the above-mentioned date the Czech Republic had two operating nuclear installations covered by the Convention on Nuclear Safety – both operated by the ČEZ, a. s. company:

Dukovany Nuclear Power Plant (Dukovany NPP) with four reactor units of VVER 440/213 type. The units were commissioned in the following years as follows (years in brackets are date of issue of final inspection approvals according to Building Act)

Unit 1 - 1985 (1988)

Unit 2 - 1986 (1988)

Unit 3 - 1987 (1989)

Unit 4 - 1987 (1990)

and

Temelín Nuclear Power Plant (Temelín NPP) with two reactor units VVER 1000/320. Both units were put into operation in accordance with the Atomic Act in 2004. Final inspection approvals according to Building Act for both units were issued in 2006.

The National Report reports on the state of implementation of individual Articles of the Convention and considers only the two above-mentioned nuclear installations.

Nevertheless, the basic philosophy and principles of nuclear safety assurance applied to these two nuclear power plants have been correspondingly applied also to the other nuclear installations in the Czech Republic – three research reactors, Interim Spent Fuel Storage Facility and Radioactive Waste Repository. The last two nuclear installations are, with regard to their nature, subject to evaluation under the Joint Convention on the Safety of Spent Fuel Management and on the Safety of Radioactive Waste Management.

Above and beyond obligations arising from the Convention on Nuclear Safety, information on research reactors is included in the Annex 8.

List of Abbreviations

ADR	European Agreement Concerning the Carriage of Dangerous Goods
ALARA	As low as reasonably achievable
ANS	American Nuclear Society
ANSI	American Nuclear Standard Institute
AOP	Abnormal Operating Procedure
AOT	Allowed outage time
AQG	Atomic Questions Group
ASSET	Assessment of Safety Significant Events Team
Atomic Act	Act No. 18/1997 Coll., on Peaceful Utilization of Nuclear Energy and Ionizing Radiation (the Atomic Act), as amended
AZ	Reactor core
BCEQ	Condenser Experimental Qualification
BI	Safety engineer
BOZP	Industrial Safety
BRS	National Security Council
CDF	Core Damage Frequency
CTP	Technical Support Center
ČEZ, a. s.	Business name of the Czech utility - joint stock company ČEZ, a. s.
ČEZ-EDU	ČEZ, a. s., Dukovany Nuclear Power Plant
ČEZ-ETE	ČEZ, a. s., Temelín Nuclear Power Plant
ČHMÚ	Czech Hydrometeorological Institute
ČSFR	Czech and Slovak Federal Republic
ČSKAE	Czech Commission for the Atomic Energy
ČSSR	Czechoslovak Socialist Republic
ČÚBP	Czech Institute for Labor Safety
DECREE	a legal regulation issued by the Ministry or the central state administration body by its authority included in the relevant Act
EGP	Energoprojekt Praha
EMS	Environmental Management System
ENIQ	European Network for Inspection Qualification
EOPs	Emergency Operation Procedure
EU	European Union
FDF	Fuel Damage Frequency
HP	Emergency preparedness
HŠ	Emergency Headquarters
HPES	Human Performance Evaluation System
HZS	Fire Rescue Service
HZSp	Fire Rescue Service of the plant
IAEA	International Atomic Energy Agency

ICAO	International Civil Aviation Organization
ICRP	International Commission for Radiation Protection
INES	International Nuclear Event Scale
INEX	International Exercise
INPO	Institute of Nuclear Power Operators
INSAG	International Nuclear Safety Advisory Group
IPPAS	International Physical Protection Advisory Service
IPSART	International Probabilistic Safety Assessment Review Team
IPERS	International Peer Review Service
IRRT	International Regulatory Review Team
IRS	Incident Reporting System
ISO	International Standard Organization
ITI	Institute of Technical Inspections
JE Dukovany	Dukovany NPP
JE Temelín	Temelín NPP
KI	Potassium iodide
KKC	Emergency Response Centre
KP	Controlled zone
KŠ	Emergency Headquarters
LaP	Limits and Conditions
LBB	Leak Before Break
LERF	Large Early Release Frequency
LRKO	Laboratory for Monitoring of Environment Radiation
IAEA	International Atomic Energy Agency
MPO	Ministry of Industry and Trade of the Czech Republic
MSK-64	Medvedev Sponheuer Karnik (seismic intensity scale)
MSVP	Interim Spent Fuel Storage Facility
MÚ	Extraordinary event
NATO	North Atlantic Treaty Organization
NUREG	Nuclear Regulation
NUSS	Nuclear Safety Series
OECD-NEA	Nuclear Energy Agency within the Organization for Economic Cooperation and Development
OED	Operator of the Electrical Output Control Room
OHO	Emergency Response Organization
OPIS	Operations and Information Center
OSART	Operational Safety Review Team
PHARE	Technical Assistance Program organized by the European Commission
PLIM	Plant Life Management
PO	Fire protection
POO	Sub-committee for population protection
PpBZ	Pre-operational (Final) Safety Report
PS	Working group

PRIS	Power Reactor Information System
PSA	Probabilistic Safety Assessment
PSCO	Civil defense working group
PSR	Periodic Safety Review
PWR	Pressurized water reactor
PZJ	Quality Assurance Program
QARAT	Quality Assurance Review Assistance Team
RMS	Radiation Monitoring Network
RÚ CO	Regional Office of Civil Defense
SAMGs	Severe Accident Management Guidelines
SAS	Safety Advisory System
SSC	System, Structure, Component
SI	Shift engineer
SPSA	Shutdown Probabilistic Safety Assessment
sHŠ	Shift Emergency Headquarters
SSSR	Union of the Soviet Socialist Republics
SÚJB	State Office for Nuclear Safety
SÚJCHBO	National Institute for Nuclear, Chemical and Biological Protection
SÚRAO	Radioactive Waste Repository Authority
SÚRO	National Radiation Protection Institute
ŠVS	Education and Training Center
SW	Software
TLD	Thermoluminescent Dosimetry
TPS	Technical Advisory Group
ÚJV Řež a. s.	Nuclear Research Institute in Řež, a.s.
ÚKŠ	Central Emergency Headquarters
US NRC	US Nuclear Regulatory Commission
VCNP	Committee for Civil Emergency Planning
VÚJE	Research Institute for Nuclear Power Plants (Slovakia)
VVER (or WWER)	Type identification for pressurized water reactors designed in the former Soviet Union
WANO	World Association of Nuclear Operators
WDPF	Westinghouse Distributed Processing Family
WENRA	Western European Nuclear Regulators Association
WPNS	Working Party on Nuclear Safety
ZHP	Emergency planning zone

1. Existing nuclear installations - Article 6 of the Convention

Each contracting party shall take appropriate steps to ensure that the safety of nuclear installations at the time the Convention enters into force for that contracting party is reviewed as soon as possible. When necessary in respect to the Convention, the contracting party shall ensure that all reasonably practicable improvements are urgently made to upgrade the safety of the nuclear installation. If such upgrading cannot be achieved, plans should be outlined to shut down the nuclear installation as soon as practically possible. The timing of the shutdown may take into account the general situation in energy production and potential alternatives, as well as the social, environmental and economic consequences.

1.1 Description of the current situation

1.1.1 Existing nuclear installations in the Czech Republic as defined in Article 2 of the Convention

At present there are four VVER-440/213 reactor units in Dukovany NPP and two VVER 1000/320 reactor units in Temelín NPP operated in the Czech Republic. Geographic locations of both the Czech nuclear power plants are shown in Fig. 1-1. Technical data of both NPPs and main changes in their designs to date can be found in the Annex 1 of this National Report.

1.1.2 Dukovany NPP

1.1.2.1 Overview of nuclear safety assessments performed and their main conclusions

Nuclear safety assurance level at Dukovany NPP has been assessed since the commencement of its construction. Since early 1990s, nuclear safety level has been reassessed in the form of analyses or evaluation within the framework of international activities. This particularly involves the IAEA and WANO missions as well as nuclear safety evaluation within the framework of accession to the European Union.

IAEA mission

OSART:

First OSART mission took place in September 1989 and a re-assessment Re-OSART mission followed in November 1991. The objective of the missions was to complement assessment of the nuclear power plant with the field of maintenance control and implementation, and subsequently check on the implementation of possible remedial measures. The conclusions from both of the missions at Dukovany NPP were favorable and additional proposals were annexed to the final report for further improvement of nuclear safety assurance. These proposals were gradually implemented [1-1], [1-2].

Another OSART mission took place in 2001. The power plant control areas, personnel quality, equipment and order condition were evaluated at a high standard, and the working procedures and regulations area was evaluated at an average. Fulfillment of the Recommendations and proposals resulting from this mission was checked by the Follow-up OSART mission in 2003. The mission team found that Dukovany NPP personnel performed an exhaustive analysis and its solution of operational safety enhancement exceeded in many

cases the extent of original recommendations from the team. In respect to solution of findings included in the original report, the power plant made great progress and the team classified many of these findings as fulfilled [1-3].

ASSET:

The ASSET mission took place in October 1993 in order to verify the event prevention system, i.e. the so-called "operational events feedback". This mission was followed by another ASSET mission in 1996 to evaluate the event prevention system based on the plant's self-assessment. Conclusions from both missions rated very favorably the standard of nuclear safety assurance at the power plant [1-4], [1-5].

Safety Issues:

A mission evaluating Safety Issues was organized in 1995 in order to assess specific design solutions of the Dukovany NPP units in connection with safety recommendations identified by IAEA in general for VVER-440/213 units in 1994-1995. The mission appreciated the approach of Dukovany NPP to the implementation of safety recommendations [1-6], [1-7].

IPERS:

The IPERS mission took place in 1998, focusing on first level PSA study, in order to assess the study and propose specific recommendations for its improvement. The final report contained 57 recommendations. All recommendations were analyzed in detail in the course of next three years and adopted recommendations were included into the PSA model and documents.

IPPAS:

The IPPAS mission was organized in 1998 in order to evaluate the implementation of the principles of physical protection of nuclear installations into the Czech law and the practice of physical protection of such. In addition, by request of SÚJB, the national system of physical protection of nuclear materials and nuclear installations was assessed, and the existing practice in the field of physical protection in the Czech Republic and the international recommendations were compared.

WANO mission

WANO Peer Review:

A mission took place for the first time in 1997 in order to verify the systems and working procedures by INPO criteria. The following fields were verified: Organization and Control, Operation, Maintenance, Technical Support, Personnel Training, Chemistry, Radiation Protection, Emergency Planning, Operational Experience Feedback.

The mission appreciated Dukovany NPP and presented, in six fields, seven strong points from Dukovany NPP as an inspiration for other power plants. Another Peer Review WANO mission took place in 2007. The conclusion from the mission was also favorable and the team found no fundamental safety-important deficiencies.

Assessment by EU

WENRA:

In 2000 the Western European Nuclear Regulators Association (WENRA) performed an assessment of nuclear safety in the EU candidate countries. The assessment of Dukovany NPP resulted in the following: the safety culture is sufficient, safety evaluation and document verification, i.e. periodic safety reviews, are performed using procedures comparable with Western practices. Once the modernization program is fully completed it is expected that

Dukovany NPP will achieve a safety level comparable with that at nuclear power plants of the same operational age in Western Europe.

AQG:

In 2001, an assessment of nuclear safety level of nuclear installations in the candidate countries was performed by WPNS group established at the AQG in connection with preparation for the EU enlargement. The report drawn up by this group in relation to Dukovany NPP recommended to the Czech Republic to submit a report on measures adopted in order to complete assessment of complete verification of the bubbler system behavior at units 1 – 4 for all design accidents. Verification of the bubbler system was completed towards the end of 2003 within PHARE projects and the joint project of the consortium of Bohunice, Dukovany, Mochovce and Pakš nuclear power plants. Work executed within the projects proved functionality of the bubbler systems of all Dukovany NPP units for all design accidents.

SÚJB evaluated report of the consortium together with the results of the OECD NEA BC (Bubble-Condenser) Steering Group Activity Report and accepted conclusions included in these reports. Based on SÚJB inspection focused on present condition of all subsystems of the containment system, their qualification and maintenance documents as well as on present status of all modifications prepared and implemented by the power plant based on BCEQ projects results, SÚJB considers the updated demonstration of Dukovany NPP containment system availability to carry out its function during the accident and after the accident throughout design life span of the power plant sufficient, for all design accident types.

Other activities

Technical audit:

A technical audit. Internal and external, was held at Dukovany NPP in 1993-1995.

The objective of the internal technical audit was to map the current status of the systems, structures and components of nuclear power plant units. That was evaluated using two approaches – first level PSA study and using a deterministic approach with the employment of Pre-operational (Final) Safety Report, studies and analyses. The internal audit was performed by the plant's specialists and the resulting output was an overall evaluation of the individual units, including proposal of modernization efforts relating to nuclear safety, reliability and operation economics.

The objective of the external technical audit was to evaluate independently the level of nuclear safety assurance at nuclear power plant units in agreement with international standards and generally recognized nuclear safety principles. The assessment was performed within the PHARE PH 4.2.9 program by a consortium of West European companies – ENAC – using the methodology for periodic safety review of nuclear power plants issued by IAEA as Safety Series (SG-012) in cooperation with SÚJB. The final report contains a set of recommendations focusing particularly on enhancement of the so-called "defense in-depth", and methodical procedure.

PSR:

SÚJB conditioned the obtainment of approval for further operation of Dukovany NPP units after 20 years by performing Periodic Safety Review (PSR) in the range specified in IAEA NS-G.2.10 instruction. This evaluation was performed in 2006 resulting in requirements on specific measures to enhance the level of nuclear safety assurance.

Nuclear installation operator utilizes other instruments (probabilistic and deterministic) to monitor continuously and to evaluate periodically the nuclear safety of nuclear installations. These instruments are described in chapter 9.1.2.

1.1.2.2 Implemented and planned measures to improve the standard of nuclear safety

First implemented measures to enhance nuclear safety were executed within the "Back-fitting of Dukovany NPP" project. This project was created as a response to the first analyses after putting the units into operation and the first findings from the Chernobyl accident under Government Decree No. 309/1986.

The Czech Republic proceeded to this step as a number of other countries, despite the fact the Chernobyl reactor had had entirely different physical and technical parameters than the pressurized water reactors employed at Dukovany NPP. The initial design of the "Back-fitting" was completed in 1990; its implementation started in 1991 and was completed in 1996.

The assessment of equipment condition and international activities in 1992-1997 (see Chapter 1.1.2.1) resulted in MORAVA "Equipment Renovation Program" elaborated as a set of requirements on modification of Dukovany NPP equipment, ensuring safe, reliable and economical operation. The program is not closed in terms of time and subject, and is updated on an annual basis.

A subgroup of activities with direct relation to fulfillment of SÚJB and IAEA requirements was selected from the MORAVA program. This subgroup is called Modernization Program and its most important project is the "I&C Renovation" – replacement of safety-important parts for digital systems, which is performed in parts during unit outages. The "I&C Renovation" is implemented on Unit 3 in full and the implementation on other units is distributed as follows: Unit 1 – 2004 to 2007, Unit 2 – 2005 to 2008, Unit 4 – 2006 to 2009.

Total list of important modifications is included in Annex 1.

1.1.3 Temelín NPP

1.1.3.1 Overview of nuclear safety assessments performed and their main conclusions

Assessment of the original design at Temelín NPP performed by Czech and Slovak specialists has been under way since the beginning of its construction. After 1989, the demand for construction of 4 Units was re-evaluated, and particularly, the level of nuclear safety assurance was assessed, taking into account experience from Western nuclear power plants. This assessment was carried out in the form of international missions aimed at independent assessing the original design and other aspects of the construction from the viewpoint of internationally recognized standards.

IAEA mission

Site Safety Review, Design Review:

A mission aimed at evaluating the site safety took place in April 1990 and mission focused on evaluation of safety systems, core design and safety analyses was held at the turn of June and July 1990. The missions concluded that the design of Temelín NPP, its siting and organization of construction did not show any significant deviations from the internationally adopted criteria.

Final reports from the missions [1-8], [1-10] included partial recommendations supposed to contribute to nuclear safety enhancement. The recommendations were applied both in the form of changes of and amendments to the design and within the organization of the construction and preparation for future operation.

OSART:

The Pre-OSART mission took place at the turn of April and May 1990 and it focused on practice in power plant construction and on preparation for safe operation. The mission concluded that the work executed at the site is on a good level. Good practices were identified, which could be of interest for other power plants and several proposals for improvement were formulated, including concurrent confirmation of the intention to replace the original I&C system [1-9].

Another OSART mission was held in 1992. This involved the so-called Follow-up to the Pre-OSART mission. The main conclusion of the mission was that in spite of large number of recommendations from previous mission the power plant made sufficient progress in addressing findings formulated by previous mission [1-11].

Another OSART mission took place in 2001. The team concluded that Temelín NPP managers are determined to get on with enhancement of nuclear safety and reliability of their power plant. In addition, the power plant personnel uniquely described, in the course of discussions and dialogues, that safety was top priority.

The Follow-up OSART mission held in 2003 aimed at assessing power plant response to recommendations defined by mission team in 2001. There were 63 % of recommendations and proposals included into the completed category, and the team appreciated generally great progress in operational safety enhancement, recommendation implementation and power plant appearance.

QARAT:

The QARAT mission held in 1994 aimed at verifying the quality assurance area. The group of experts confirmed distinct development in this area [1-12].

LBB Application Review:

Missions on LBB analyses took place in 1993, 1994 and 1995 at Temelín NPP. All missions concluded that LBB methodology was successfully applied at Temelín NPP in compliance with world practices, and that postulated fractures in deterministic analyses are unlikely to occur.

Safety Issues:

A mission evaluating Safety Issues identified by the IAEA for nuclear power plants with VVER-1000/320 type reactors [1-15] was held in 1996. The mission evaluated the plant's upgraded design, implementation of previously proposed alterations and its preparedness for operation, including issue of compatibility of the original Russian design with proposed and implemented changes, which included the implementation of modern Western technology.

In general, the mission very highly commended the operator, ČEZ, a. s., that they had spent a significant effort to improve the Temelín NPP's design [1-16]. The mission emphasized that the combination of Eastern and Western technology in the Temelín NPP design was very carefully considered. In the mission's opinion, in some cases such a combination of Eastern and Western technologies resulted in a significant improvement of the safety assurance level in comparison with international practices.

A follow-up mission of the same type took place in 2001. The status of each safety issue for VVER 1000/320 units as specified by IAEA can be found in Annex 2.

IPERS, IPSART:

IPERS – a mission on the PSA study took place in 1995 and 1996. The mission concluded that Temelín NPP carefully adopted PSA methodology and the results confirmed, in spite of conservative assumptions, high level of power plant safety. In 2003, the IPSART mission reexamined the previous verifications and focused in detail on updated models of probabilistic safety assessment of the current design and operation of the power plant. A six-fold decrease in occurrence of the event resulting in reactor core damage was declared by means of these new probabilistic assessment models for internal initiation events.

Fire Safety:

A mission focused on fire protection took place in 1996. It was stated that substantial improvements were made in compliance with international trends of fire protection [1-14].

IPPAS:

A mission was organized in 1998 and focused on the field of physical protection assurance in the construction period. The mission further monitored the implementation process of physical protection technical system, safety analysis preparation and overall concept of the method of physical protection assurance. The experts appreciated the level of physical protection and its licensing. Final assessment proved that the system meets the international requirements in full.

A Follow-up mission took place in 2002. The objective of the mission was to assess the final state of Temelín NPP physical protection assurance on the level of operated nuclear installation, and as the case may be, present to Temelín NPP recommendations or proposals resulting in improvement of the physical protection system.

The mission concluded that technical support of Temelín NPP perimeter is implemented in an outstanding manner, the physical protection system is highly integrated and systematic approaches were used and are still used in implementation of the physical protection system. The physical protection system of Temelín NPP is on the level of the best Western installations and the personnel providing physical protection system are qualified and professional.

Preparedness and Commissioning Review mission:

This mission took place in 2000. The objective was to assess operational practices in the field of Management, Organization and Control, Operation, Maintenance and Commissioning. The mission concluded that the systems are handed over and under control of operating organization in condition suitable for power plant commissioning.

Site Seismic Hazard Assessment:

A mission took place in 2003 and resumed partially the mission held in 1990. It was stated that local seismic monitoring network was built in linkage to the recommendations in the vicinity of Temelín NPP. The mission concluded that acceleration value of 0.1 g for seismic level (SL2) is a good value for Temelín NPP.

WANO mission

WANO Peer Review:

A mission took place for the first time in 2004 and the following fields were verified: Organization and Control, Operation, Maintenance, Technology, Radiation Protection,

Operational Experience, Chemistry and Fire Protection. The WANO team classified Temelín NPP as having a good operation safety enhancement program, good and experienced personnel, and found no fundamental safety-important deficiencies [1-17].

A Follow-up Peer Review WANO mission took place in 2006. Out of 13 fields for improvement from the previous mission, six fields were assessed as completed in full and seven fields were assessed as fields with satisfactory improvement, but with uncompleted activities. At the same time, the mission submitted its proposals for further continuation in such fields [1-18].

Assessment by EU

WENRA:

The assessment of nuclear safety in the EU candidate countries was carried out in 1998 and 2000. The following is included in the assessment report: the program for Temelín NPP safety enhancement is the most comprehensive one ever used for VVER-1000/320 units, international cooperation has significantly influenced safety improvements (design, operation, safety approvals) and development of safety culture at the plant, combination of Eastern and Western technologies has been successfully handled.

Interfaces between different technologies have been considered within the modernization program and a standard Western approach has been used for combining of Eastern and Western technologies. Only two safety issues have been mentioned as requiring more clarification and if resolved, Temelín NPP will achieve a safety standard comparable with the safety standard of PWR units operated in the West.

The process of combining Eastern and Western technologies was also evaluated by the ENCONET Consulting Company (Austria). The conclusion has been similarly favorable as that by WENRA.

AQG:

Two recommendations were included in the AQG report in relation to Temelín NPP: assure assessment proving sufficient protection against high-energy pipe break and potential subsequent damage to steam line and feedwater piping (short-term priority), and inform on measures to complete the proof of reliable function of important steam relief and safety valves at dynamic load with steam-water mixture flow. A report on implementation of these recommendations, which were adopted, was submitted to the EC in November 2002.

The high-energy pipe break protection is based on combination of extremely low likelihood of a sudden break of the pipeline under normal or abnormal operation conditions or in seismic event, application of French "super pipe" concept (that precludes sudden pipe break for the area from containment penetration to anchoring point), 100 % qualified ultrasonic inspections, corrosion-erosion monitoring program, etc. Whip restraints are installed at certain points in accordance with recognized Western standards. Computer programs used for assessment are validated in full.

Reliable function of important steam relief and safety valves for the case of occurrence of two-phase steam-water medium, i.e. qualification of respective valves, was demonstrated, in accordance with international standards, by creating new qualification set of knowledge. The principle is based on assignment of the valve under review to the group of valves of the same manufacturer and with comparable characteristics that were tested for full scope of required parameters.

Other activities

Consultants meeting on the Temelín NPP design changes held at the IAEA Headquarters in 1994 in Vienna [1-13].

Nuclear installation operator utilizes other instruments (probabilistic and deterministic) to monitor continuously and to evaluate periodically the nuclear safety of nuclear installations. These instruments are described in chapter 9.1.2.

1.1.3.2. Main changes in the design and other measures for the enhancement of nuclear safety implemented as a result of the analyses

Based on assessments mentioned in Chapter 1.1.3.1, technical improvements were proposed, implementation of which assured attainment of Western NPP standards for Temelín NPP. Recommendations were implemented in the form of amendment to the Basic and Detail design. The following may be mentioned as supporting improvements:

- Replacement of the I&C system, including its new design,
- Replacement of the nuclear fuel, including a new core design,
- Replacement of the original radiation monitoring system, including its design,
- Replacement and supplementing of the diagnostic system,
- Replacement of original cables with fire-proof and non-propagating fire ones,
- Significant changes in the electric part.

Total list of important modifications is included in Annex 1.

1.2 Statement on the implementation of the obligations concerning Article 6 of the Convention – position of the Czech Republic on the current status of nuclear safety and future operation of the nuclear installations

All the above-mentioned studies and analyses unequivocally prove that the level of nuclear safety provision at Dukovany NPP and Temelín NPP units is high and in compliance not only with current requirements valid in the Czech Republic but also with internationally accepted practices.

The nuclear safety status has been systematically reviewed and evaluated from the viewpoint of the latest scientific and technical knowledge. Necessary activities are planned and implemented so that the current status is maintained or further improved in the future. By reasons provided in this chapter it is evident that the requirements resulting from Article 6 of the Convention are fulfilled.

Fig. 1-1 Map of the Czech Republic indicating the Temelín and Dukova NPPs.

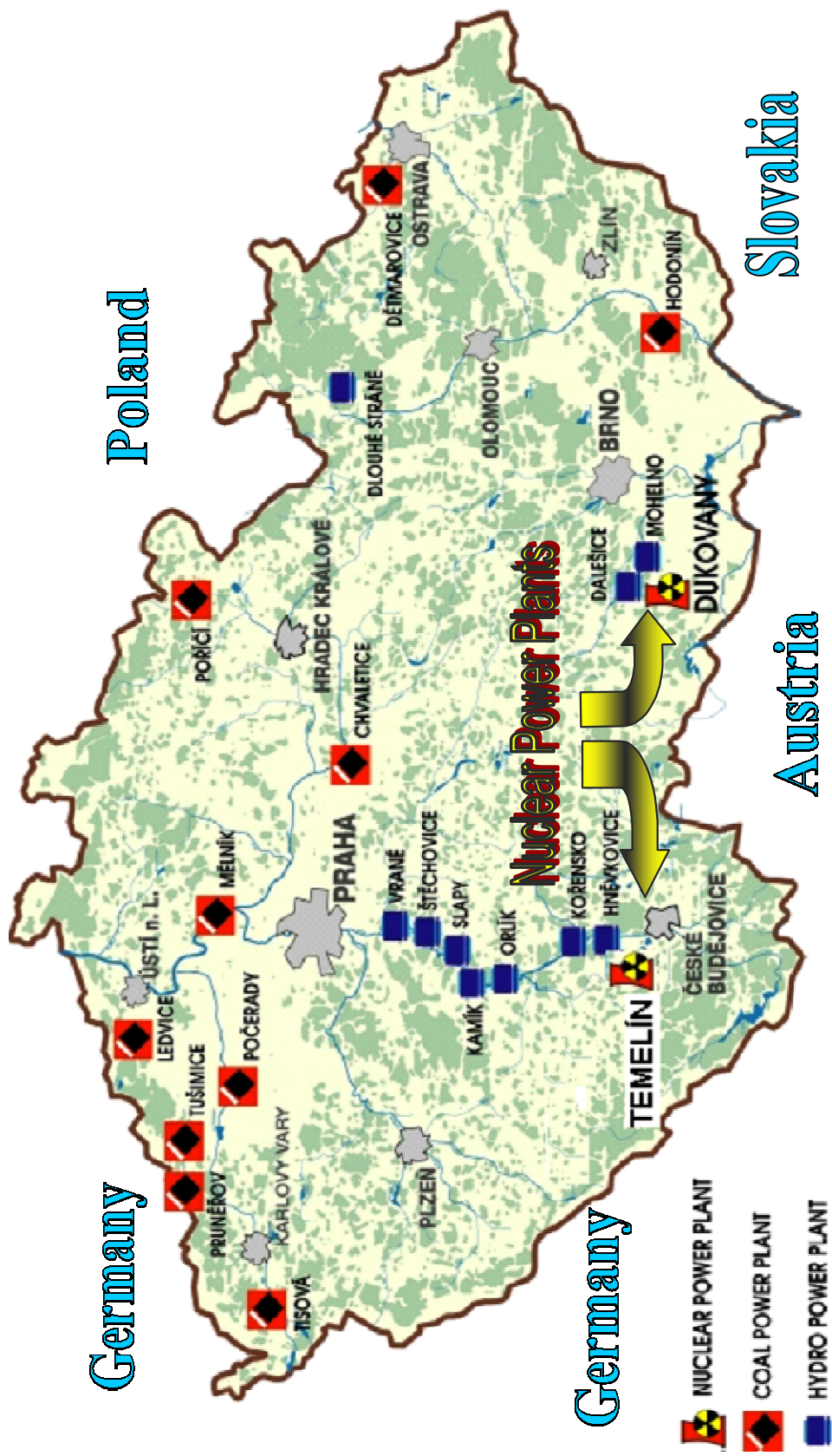

2. Legislative and Regulatory Framework - Article 7 of the Convention

1. *Each contracting party shall establish and maintain a legislative and regulatory framework to govern the safety of nuclear installations.*
2. *The legislative and regulatory framework shall provide for:*
 - (i) *the establishment of applicable national safety requirements and regulations;*
 - (ii) *a system of licensing with regard to nuclear installations and the prohibition of the operation of a nuclear installation without a licence;*
 - (iii) *a system of regulatory inspection and assessment of nuclear installations to ascertain compliance with applicable regulations and the terms of licences;*
 - (iv) *the enforcement of applicable regulations and of the terms of licences, including suspension, modification or revocation.*

2.1 Description of the current situation

2.1.1 Development of national legislative and regulatory framework

The legislative and regulatory framework for the nuclear energy industry in the Czech Republic has had a relatively long history. Its beginnings, dating back to second half of 1970s, are connected with the construction and operation of the first nuclear power plants with VVER reactors in former Czechoslovakia.

The next stage of the development of state supervision is connected with the establishment of the independent state Czech Republic at the turn of 1992–1993. The Act No. 21/1993 Coll. established the State Office for Nuclear Safety (SÚJB), which took over, from January 1, 1993, an office to carry out the state supervision of nuclear safety in the Czech Republic.

Development of a new Act began practically at the same time, with the objective to comprehensively re-codify utilization of nuclear energy and ionizing radiation and, in particular, to address issues insufficiently regulated by then, e.g. radioactive waste management, liability for nuclear damages, emergency preparedness etc.

2.1.2 Valid legislation in the area of utilization of nuclear energy and ionizing radiation

The Atomic Act (Act No. 18/1997 Coll., on peaceful utilization of nuclear energy and ionizing radiation) was approved by the Czech Republic's Parliament in January 1997. The Atomic Act entrusted execution of the state administration and supervision of peaceful utilization of nuclear energy and radiation practices to SÚJB and redefined the scope of its competency and powers.

The Atomic Act has defined conditions for peaceful utilization of nuclear energy and ionizing radiation, including the activities requiring SÚJB license. An extensive list of obligations of the licensees includes, among other items, obligations relating to their preparedness for a radiation accident.

In the area of radioactive waste management, the Act entrusted responsibility for final

disposal of all radioactive wastes to the state and ordered to the Ministry of Industry and Trade of the Czech Republic to establish a new governmental organization for the purpose – the Administration of Radioactive Waste Repositories. Activities of the Administration shall be funded from a so-called "nuclear account" whose main income is represented by payments from radioactive waste producers.

The Atomic Act transferred into the Czech legal system a number of obligations resulting from the Vienna Convention on Civil Liability for Nuclear Damage and Joint Protocol relating to the Application of the Vienna and Paris Conventions, to which the Czech Republic acceded.

Since 1997 the Atomic Act has been amended several times. The most significant amendment was performed by the Act No. 13/2002 Coll., which was particularly adopted in connection with the preparation of the Czech Republic for accession to the European Union, aimed at enabling the implementation of obligations arising from newly concluded international treaties. In connection with this Act, which became effective on July 1, 2002, the respective SÚJB Decrees were amended. The provisions related to radiation protection were amended in particular by reason of assuring the compatibility with the respective European directives. Another significant amendment was performed by Act No. 253/2005 Coll., in connection with harmonization with international regulations in the field of technical safety. Last amendment of the Atomic Act was performed by Act No. 186/2006 Coll.

The abbreviation "Atomic Act" used hereinafter is used for quotation of Act No. 18/1997 Coll., as amended.

The Atomic Act authorized the SÚJB, and in strictly defined cases other bodies of the state administration, to issue a set of related implementing regulations, such as the following:

- **SÚJB Decree No. 214/1997 Coll.**, on quality assurance in activities related to the utilization of nuclear energy and in radiation practices, and laying down criteria for the assignment and categorization of classified equipment into safety classes,
- **SÚJB Decree No. 215/1997 Coll.**, on criteria for siting nuclear installations and very significant ionizing radiation sources,
- **SÚJB Decree No. 106/1998 Coll.**, on nuclear safety and radiation protection assurance during commissioning and operation of nuclear facilities,
- **SÚJB Decree No. 309/2005 Coll.**, on assurance of technical safety of selected equipment,
- **SÚJB Decree No. 195/1999 Coll.**, on basic design criteria for nuclear installations with respect to nuclear safety, radiation protection and emergency preparedness,
- **SÚJB Decree No. 185/2003 Coll.**, on decommissioning of nuclear installation or workplaces of category III or IV,
- **SÚJB Decree No. 146/1997 Coll.**, specifying activities directly affecting nuclear safety and activities especially important from radiation protection viewpoint, requirements on qualification and professional training, on method to be used for verification of special professional competency and for issue authorizations to selected personnel, and the form of documentation to be approved for the licensing of expert training of selected personnel, as amended by SÚJB Decree No. 315/2002 Coll.,
- **SÚJB Decree No. 307/2002 Coll.**, on radiation protection, as amended by the SÚJB Decree No. 499/2005 Coll.,

- *SÚJB Decree No. 318/2002 Coll.*, on details of emergency preparedness of nuclear installations and workplaces with ionizing radiation sources and on requirements on the content of on-site emergency plan and emergency rule, as amended by SÚJB Decree No. 2/2004 Coll.,
- *SÚJB Decree No. 319/2002 Coll.*, on performance and management of the national radiation monitoring network, as amended by SÚJB Decree No. 27/2006 Coll.,
- *SÚJB Decree No. 193/2005 Coll.*, sets the list of theoretical and practical areas forming the education and preparation content required in the Czech Republic for the performance of regulated activities belonging to the competence of SÚJB,
- *Government Order No. 11/1999 Coll.*, on emergency planning zone.

A list of the above-mentioned decrees is provided in the Annex 5, and a complete text of the Atomic Act, including its implementing decrees is available at the SÚJB web pages www.sujb.cz.

In 2000 the so-called "Emergency Acts" were adopted, a list of which, together with other legal regulations ensuring implementation of the Atomic Act, is provided in the Annex 5.

The legislative framework is concluded with recommendations and guidelines published since 1978 by the State Office for Nuclear Safety in a special non-periodic series of publications: "Safety of Nuclear Installations - Requirements and Guidelines". A total of 55 documents (guidelines, translations of IAEA recommendations, etc.) were issued in this series of publications in 1994 – 2007.

Approval process, inspections and enforcement of compliance with the regulations

The basic legal standard governing the approval process for nuclear installations includes, in addition to the above-mentioned Atomic Act and Act No. 342/2006 Coll., the Building Act, as amended, effective as from January 1, 2007.

Other most important legal regulations related to this area are in particular Act No. 500/2004 Coll., on administrative proceedings, as amended; Act No. 552/1991 Coll., on state inspection, as amended; Act No. 100/2001 Coll., on environmental impact assessment as amended; Act No. 106/1999 Coll., on free access to information, as amended and Act No. 123/1998 Coll., on free access to environmental information, as amended as well as other legal regulations.

According to new Civil Construction Act, the issuance of key resolution for all facilities containing nuclear installations, i.e. planning and site decision are entrusted to local department of planning and building control. The Ministry of Industry and Trade is now entrusted with the issuance of other resolutions (construction permit, operation license and decommissioning permit).

Provided the related procedure involves interests protected by special regulations, such as nuclear safety or radiation protection, the department of planning and building control shall decide in cooperation with or based on an approval from the respective state administration bodies protecting such interests. A respective state administration body shall condition its approval upon fulfillment of conditions specified in its resolution issued in agreement with the special act entitling the body to do so. The bodies include in particular:

- technical inspection bodies dealing with conventional safety, including safety of pressure components and electric systems,

- regional and municipal authorities in respect to fire safety, waste management, water consumption and effluents discharge,
- Czech Environmental Inspection – in respect to air pollution,
- Local body in charge of public health protection in respect to industrial safety in agreement with Act No. 258/2000 Coll., on public health protection, as amended.

Section 110 paragraph 2 of the Civil Construction Act directly imposes liability upon operator to present binding approaches to respective departments of planning and building control according to special regulations, in this case of the Atomic Act.

The Atomic Act establishes activities for which a license issued by the SÚJB is required. Apart from the main activities - siting, construction and operation, there are a number of other activities, e.g. SÚJB licenses for individual stages of nuclear installation commissioning, for reconstruction or other changes affecting nuclear safety, for discharge of radionuclides into the environment, etc. More detailed information is provided in chapter 3.2.1.

Act No. 17/1992 Coll., on the environment, as amended, and especially Act No. 100/2001 Coll., on environmental impact assessment, as amended, impose the obligation to assess constructions from the viewpoint of their impact on the environment (to perform the "Environmental Impact Assessment") within special proceedings open to the public represented by the respective municipality, which is a party to the proceedings, or by the civil association. The Ministry of the Environment is the state administration body responsible for the issuance of a resolution concerning the environmental impact of the nuclear power plant.

Inspection activities to be performed by SÚJB are defined in detail in Section 39 of the Atomic Act, as well as in Act No. 552/1991 Coll. on state inspection, as amended.

Instruments applied to enforce the legislative requirements are regulated by Sections 40 and 41 of the Atomic Act. SÚJB is authorized to require the inspected person to remedy the situation, to perform technical checks, inspections or functional ability tests and to impose penalties for violating obligations established in the Atomic Act.

In case there is a risk of delay, the SÚJB is authorized to impose the obligation to reduce the power output or to suspend operation of the nuclear installation. Issues of alteration, cancellation and cessation of a license are regulated by Section 16 of the Atomic Act, which authorizes SÚJB to restrict or to suspend performance of the licensed activity if the licensee has failed to fulfill the obligations thereunder.

More details of the legislation mentioned above and the licensing procedure below, are described later, particularly in chapters 9, 10, 11, 12, 13 and 14.

2.1.3 Multilateral international treaties and treaties with IAEA

A part of the valid Czech legislation in the given area are the following international treaties signed by the Czech Republic (or the former Czechoslovak Socialist Republic and later the Czech and Slovak Federal Republic):

- The Convention on the Physical Protection of Nuclear Materials (in Vienna on October 26, 1979, communication of the MZV No. 27/2007 Coll.).
- The Convention on Early Notification of a Nuclear Accident (in Vienna on September 26, 1986, communication of the MZV No. 116/1996 Coll.).
- The Convention on Assistance in the Case of a Nuclear or Radiation Accident (in Vienna on September 26, 1986, communication of the MZV No. 115/1998 Coll.).

- Nuclear Safety Convention (in Vienna on June 17, 1994, communication of the MZV No. 67/1998 Coll.).
- Vienna Convention on Civil Liability for Nuclear Damage (in Vienna on May 21, 1963, ratified, communication of the MZV No. 133/1994 Coll.).
- The Joint Protocol relating to the Application of the Vienna and Paris Conventions on Liability for Nuclear Damage (in Vienna in 1988, ratified, communication of the MZV No. 133/1994 Coll.).
- The Protocol on Amendment to the Vienna Convention on Civil Liability for Nuclear Damage (in Vienna on September 12, 1997, signed by the Czech Republic on June 18, 1998, however it has not been ratified as yet).
- The Comprehensive Nuclear Test Ban Treaty (has not become valid as yet, the Czech Republic's Government Order No. 535/1996).
- Joint Convention on the Safety of Spent Fuel Management and on the Safety of Radiological Waste Management (in Vienna on September 5, 1997, UV No. 593/1997, ratified on March 26, 1999).
- The Treaty on the Non-Proliferation of Nuclear Weapons (NPT) (Decree by the MZV No. 61/1974 Coll., of March 29, 1974).
- The Convention on Supplementary Compensation for Nuclear Damage (in Vienna on September 12, 1997, the Government Order No. 97/1998, signed by the Czech Republic, however has not been ratified).
- The Convention on Environmental Impact Assessment in a Transboundary Context (Espoo, February 25, 1991, ratified on February 26, 1991, Decree by the MZV No. 91/2001 Coll.).
- The Convention on Korean Energetics Development Organization (KEDO) – letter of the MZV on acceptance of the Agreement of March 9, 1995 and of the supplemental Protocol of 1997 by the Czech Republic dated January 27, 1999; the Czech Republic became a member on February 9, 1999.
- The Agreement between the Czech Republic and the International Atomic Energy Agency on Safeguards, based on the Treaty on Non-proliferation of Nuclear Weapons (in Vienna on September 18, 1996, through communication of the MZV No. 68/1998 Coll.).
- The Supplemental Protocol to the Agreement between the Czech Republic and the International Atomic Energy Agency on Safeguards, based on the Treaty on Non-proliferation of Nuclear Weapons (in Vienna on September 28, 1999, through communication of the MZV No. 74/2003 Coll.).
- Adapted supplemental Agreement on Technical Assistance provided by the International Atomic Energy Agency to Government of the Czech and Slovak Federal Republic (in Vienna on September 20, 1990, No. 509/1990 Coll.).

The obligation to inform about significant events relating to nuclear safety is also established in the bilateral agreements entered by the Czech Republic or its predecessors.

2.1.4 WENRA

Early in 2006, the WENRA released results of the work of two working groups – Reactor Harmonisation (RHWG) and Wastes and Decommissioning (WGND). The RHWG group prepared the harmonization study in the field of nuclear safety of nuclear installations, which

encompassed comparison of national legislation with the so-called reference safety levels. The reference levels in 18 subject areas for NPP design and operation were based on new, partially modified, IAEA recommendations (Safety Standards) for this area. This comparison showed that these requirements are formulated in the overwhelming majority of the countries in documents on the operative level, e.g. in decisions, permits, etc., however, not directly in legally binding documents of act and decree types.

The objective of the WENRA is to complete the harmonization of national legislation with reference levels by the end of 2010. In April 2006, the SÚJB established a working group to analyze the current state in detail and draw up a draft Action Plan, which was presented in the WENRA session.

SÚJB experts actively participated in the work of both WENRA working groups, and the SÚJB representative presides over the WGWD working group. The Czech Republic took over the presidency of the WENRA for three years on November 10, 2006.

2.2 Statement on the implementation of the obligations concerning Article 7 of the Convention

A system of the described legal documents – acts, decrees, governmental orders, international treaties and intergovernmental agreements by its nature and contents meets the requirements established in paragraphs 1 and 2 of Article 7 of the Convention.

3. Regulatory Body - Article 8 of the Convention

1. *Each Contracting Party shall establish or designate a regulatory body entrusted with the implementation of the legislative and regulatory framework referred to in Article 7, and provided with adequate authority, competence and financial and human resources to fulfil its assigned responsibilities;*
2. *Each Contracting Party shall take appropriate steps to ensure effective separation between the functions of the regulatory body and those of any other body or organization concerned with the promotion or utilization of nuclear energy.*

3.1 Description of the current situation

3.1.1 Mandate and competence of the regulatory body

The SÚJB (State Office for Nuclear Safety) was established through the Act No. 21/1993 Coll., passed by the Czech National Council as a central authority of the state administration of the Czech Republic. In agreement therewith after the dissolution of the Czech and Slovak Federal Republic, the SÚJB assumed power and competency of the former ČSKAE (Atomic Commission) in respect to the state supervision of nuclear safety and nuclear materials. In July 1995 the Czech Republic's Parliament extended the SÚJB competence to include issues of protection against ionizing radiation. As a result Czech Regulatory bodies in charge of nuclear safety and radiation protection have merged and the SÚJB has become an integrated state administration body which carries out the state supervision for the whole area of the utilization of nuclear energy and ionizing radiation.

Since July 1, 1997 the competence of the SÚJB has been defined by the Atomic Act according to its Section 3:

(1) State administration and supervision of the utilization of nuclear energy and ionizing radiation and in the field of radiation protection shall be performed by the State Office for Nuclear Safety (hereafter referred to as "the SÚJB").

(2) The SÚJB

- a) shall carry out State supervision of nuclear safety, nuclear items, physical protection, radiation protection and emergency preparedness and shall inspect the adherence to the fulfillment of the obligations arising out of this Act;*
- b) shall monitor non-proliferation of nuclear weapons and carry out state supervision of nuclear items and physical protection of nuclear materials and nuclear installations;*
- c) shall issue licenses to perform practices governed by this Act and shall issue type-approvals for packaging assemblies for transport and storage of nuclear materials and radioactive substances given in an implementing legal regulation, ionizing radiation sources and other products;*
- d) shall issue authorizations for activities performed by selected personnel;*
- e) shall approve documentation, programs, lists, limits, conditions, methods of physical protection assurance, emergency rules and, subject to discussion with the relevant Regional Authorities and relevant Municipal Authorities of Municipalities with extended competence of compatibility with off-site emergency plans, on-site emergency plans and*

- their modifications;*
- f) shall establish conditions, requirements, limits, maximum permitted levels, maximum permitted levels of radioactive contamination of foodstuffs, guidance levels, dose constraint, reference levels, diagnostic reference levels, exemption levels and clearance levels;*
 - g) shall establish the emergency planning zone and, if applicable, its further structuring, and shall approve delineation of the controlled area;*
 - h) in accordance with an implementing legal regulation, shall establish requirements on emergency preparedness of licensees, and shall inspect their fulfillment;*
 - i) shall monitor and assess the exposure status and regulate exposure of individuals;*
 - j) shall issue, register and verify personal radiation passport; related details shall be set out in an implementing legal regulation;*
 - k) shall provide information to municipalities and Regional Authorities concerning radioactive waste management within their territory of administration;*
 - l) shall control the activity of the National Radiation Monitoring Network, the functions and organization of which shall be set out in an implementing legal regulation, shall provide for the functioning of its head-office, and shall provide for the activities of an Emergency Response Center and for an international exchange of information on the radiation situation;*
 - m) shall establish State and Professional examination commissions for verification of special professional competence of selected personnel, and shall issue statutes for these commissions and specify activities directly affecting nuclear safety and activities especially important from the radiation protection viewpoint;*
 - n) shall maintain a State system of accounting for and control of nuclear materials and data and information in accordance with international agreements binding on the Czech Republic, and shall set out requirements for accounting methods and inspection thereof in an implementing legal regulation;*
 - o) shall maintain a national system for registration of licensees, registrants, imported and exported selected items, ionizing radiation sources, and a record of exposure of individuals;*
 - p) shall ensure, by means of the National Radiation Monitoring Network and based on assessment of a radiation situation, the availability of background information necessary to take decisions aimed at reducing or averting exposure in the case of a radiation accident;*
 - r) shall approve a classification of nuclear installation or its components and nuclear materials into appropriate categories, from the physical protection viewpoint;*
 - s) shall perform the function of the national authority for an international verification of a comprehensive ban of nuclear tests;*
 - t) shall ensure international co-operation within its sphere of competence and, in particular, shall be an intermediary of technical co-operation with the International Atomic Energy Agency, and within its sphere of competence shall communicate information to the European Commission or, if applicable, to other bodies of the European Union;*
 - u) shall decide on assurance of handling nuclear items, ionizing radiation sources or radioactive wastes having been treated inconsistently with rules of law, or where the detrimental condition is not being removed;*
 - v) shall be obliged to give out information according to special legal provisions and once a*

- year to publish a report on its activities and submit it to the Government and to the public;*
- w) shall establish technical requirements to assure technical safety of selected systems, structures and components;*
- x) upon agreement with the administration office, shall inspect the activity of the authorized persons;*
- y) shall exercise the opinion on development policy and planning documents from the viewpoint of safety and radiation protection in activities related to nuclear energy utilization and in activities resulting in exposure.*

In 2005, the competence of the SÚJB has been extended pursuant to amendment of the Atomic Act by including the competence of the surveillance of technical safety of special-designed systems, structures and components for nuclear installation (see letter w) and x) above). Special-designed, systems, structures and components for nuclear installations may be used on their assessment by legal person entrusted for this purpose by procedure according to special legal regulation.

The competence of the SÚJB has been further extended by Act No. 19/1997 Coll., to include state administration and inspecting of the ban on chemical weapons and by a similar amendment governed by the Act No. 281/2002 Coll., in respect to the ban on biological weapons.

3.1.2 Rights and responsibilities of the regulatory body

Section 9, paragraph 1 of the Atomic Act establishes the following conditions for the utilization of nuclear energy and ionizing radiation:

(1) A license issued by the SÚJB is required for:

- a) siting of a nuclear installation or radioactive waste repository;*
- b) construction of a nuclear installation;*
- c) particular stages, laid down in an implementing legal regulation, of nuclear installation commissioning;*
- d) operation of a nuclear installation;*
- e) restart of a nuclear reactor to criticality following a fuel reload;*
- f) reconstruction or other changes affecting nuclear safety, radiation protection, physical protection and emergency preparedness of a nuclear installation or category III or IV workplace;*
- g) particular stages of decommissioning of a nuclear installation or category III or IV workplace to the extent and in the manner established in an implementing legal regulation;*
- h) discharge of radionuclides into the environment to the extent and in the manner established in an implementing legal regulation;*
- i) ionizing radiation sources management to the extent and in the manner established in an implementing regulation;*
- j) radioactive waste management to the extent and in the manner established in an implementing legal regulation;*
- k) import or export of nuclear items or transit of nuclear materials and selected items;*
- l) nuclear materials management;*
- m) transport of nuclear materials and radioactive substances laid down in an implementing legal regulation; this license does not relate to the person performing the transport, or to the carrier, unless he is simultaneously the shipper, or consignor or consignee;*

- n) professional training of selected personnel (Section 18 paragraph 5);*
- o) re-import of radioactive waste originated in the processing of materials exported from the Czech Republic;*
- p) international transport of radioactive wastes to the extent and in the manner established in an implementing regulation;*
- r) performance of personal dosimetry and other services significant from the viewpoint of radiation protection to the extent and in the manner established in an implementing regulation;*
- s) adding of radioactive substances into consumer products during their manufacturing or preparation or import or export of such products.*

Other provisions of the Atomic Act define:

- conditions to be fulfilled before a license is issued (Section 10),
- probity and professional competence of the applicant for a license (Sections 11 and 12),
- application for a license (Section 13),
- SÚJB administrative procedure (Section 14),
- license particulars (Section 15),
- alterations, cancellations and cessation of license (Section 16).

Execution of the state supervision of peaceful utilization of nuclear energy and ionizing radiation is governed by Chapter 6 of the Atomic Act, which comprises:

- supervising activities of the SÚJB (Section 39),
- remedial measures (Section 40),
- penalties (Sections 41 and 42).

Thus, the Atomic Act, together with Act No. 552/1991 Coll., on state inspection, as amended, which generally governs procedure of the state administration bodies when performing inspection activities, provides the SÚJB with corresponding power and competency for execution of the state supervision. The SÚJB checks whether the bodies which obtained a license in accordance with Section 9, paragraph 1 observe the requirements of the Atomic Act and other relevant regulations. Inspection activities of the SÚJB are governed in detail by Section 39, paragraph 1 of the Atomic Act.

The SÚJB inspection staff is nuclear safety and radiation protection inspectors appointed by the Chairperson of SÚJB. They work at the SÚJB Headquarters and directly at the sites of Dukovany and Temelín nuclear power plants, as well as in the Regional Centers (see Chapter 3.1.4). Within their inspection activities, the inspectors and also the Chairperson of SÚJB, are particularly authorized to:

- enter at any time facilities, installations, operational areas, territories and other workplaces of inspected persons where activities related to nuclear energy utilization or radiation practices are carried out,
- check on the compliance with requirements and conditions of nuclear safety, radiation protection, physical protection and emergency preparedness and inspect the nuclear installation conditions, adherence to the limits and conditions and operational procedures,
- demand evidence of fulfillment of all set obligations for the provision of nuclear safety, radiation protection, physical protection and emergency preparedness of a

nuclear installation and to perform measurements and collect samples at the premises of inspected persons, such as are necessary for checking the compliance with the Atomic Act and other regulations issues on its basis,

- verify professional competence and special professional competence under the Atomic Act,
- participate in investigations of events with an impact on nuclear safety, radiation protection, physical protection and emergency preparedness, including unauthorized handling of nuclear items or ionizing radiation sources.

A SÚJB inspector shall be authorized, depending on nature of the identified shortcoming, to:

- require the inspected person to remedy the situation within a set period of time,
- charge the inspected person to perform technical inspections, reviews or testing of function condition of the installation, its parts, system or its assemblies, if necessary for verification of nuclear safety;
- propose a penalty.

The SÚJB is authorized, in the event of a hazard arising from delay or an occurrence of undesirable situations with an impact on nuclear safety, radiation protection, physical protection and emergency preparedness, to issue a provisional measure imposing on the inspected person the obligation to reduce the power output or suspend operation of the nuclear installation, suspend an installation of components or systems of nuclear installations. Further it is authorized to prohibit the handling of nuclear items, ionizing radiation sources or radioactive waste, or impose on the inspected person to suffer the imposition of management by another person, at the expense of the inspected person.

Violation of a legal obligation established in the Atomic Act may be fined by the SÚJB with a penalty up to the amount specified in Section 41 and in agreement with the rules specified in Section 42. The binding procedures for inspection activities are set forth in the SÚJB internal regulations.

3.1.3 Position of the regulatory body within the state administration structure

The SÚJB is an independent central state administration body in the field of nuclear safety and radiation protection. Within its power and competency the SÚJB is responsible neither to the Ministry of Trade and Industry nor to the Ministry of the Environment. The statute of the SÚJB within the state administration structure is shown in Fig. 3-1. The SÚJB has its own budget approved by the Parliament of the Czech Republic as a part of the state budget. The SÚJB is headed by a Chairperson appointed by the Government of the Czech Republic. Since 1984 the SÚJB (theretofore ČSKAE) submits regular annual reports on results of its activities to the Government of the Czech Republic.

3.1.4 Structure of the regulatory body, its technical support, material and human resources

For 2007, the SÚJB was allotted a staff of 197 persons, approximately two thirds of that number represents nuclear safety and radiation protection inspectors. The SÚJB budget for 2007 is approximately 362 million Czech crowns (about 12.8 million euro), total budget including the organizational units of the State and budget organizations included in its department is 384 million Czech crowns (about 13.6 million euro). Under the present Czech Republic conditions, the material and human resources are sufficient for the fulfillment of basic functions to be performed by the SÚJB under the law.

The organizational structure of the SÚJB is shown in Fig. 3-2, and it consists of:

- Department of Nuclear Safety, including Section of Nuclear Installations Assessment with Technical Safety and Systems Integrity Unit and Safety Analyses Unit. Section of Nuclear Installations Inspection with Inspection of Systems Unit and Feedback Unit and two Units of Resident Inspectors (at Dukovany NPP and Temelín NPP) and Spent Fuel and Radwaste Management Unit;
- Department of Radiation Protection, which includes Regulation of Exposures Section, Radiation Sources Section including Regional Centers in Prague, Plzeň, Ústí nad Labem, Hradec Králové and Ostrava, Radiation Protection of Fuel Cycle Section including Regional Centers in Kamenná, České Budějovice and Brno, and Radiation Protection Activities Assessment Unit;
- Department of Management and Technical Support, which includes International Cooperation Section, Financial Section, and Office Bureau, Legal Unit and Control of Non-Proliferation Section (nuclear, biological and chemical weapons);
- Emergency Response Center;
- Unit for coordination of activities associated with the accession to the European Union;
- Internal audit;
- Director for Security Affairs;
- Advisory Board of SÚJB Chairperson.

Moreover, the SÚJB also acts as a managing authority of the National Radiation Protection Institute (SÚRO), an organization unit of the State providing expert and technical support in the area of radiation protection, and public research institution - the National Institute for Nuclear, Chemical and Biological Protection (SÚJCHBO), an allowance organization providing for primary expert and technical supports for the SÚJB in chemical and radiation safety. Responsibilities within the SÚJB organizational structure are established by the Organizational Statute and other internal regulations.

Advisory groups made up of independent experts have been used since 1998 to provide expert support to the SÚJB in respect to nuclear safety and radiation protection.

3.1.5 Relations between the regulatory body other state administration bodies

It is obvious from the above-listed legislative documents and the state administration structure in the Czech Republic, that power and competency of the SÚJB are sufficient to perform the state supervision of nuclear safety and radiation protection. At the same time the scope of powers assigned to the SÚJB does not clash with that of any other state administrative body.

3.1.6 Independent assessments of the national regulatory body

Chapters 2 and 3 hereof describe the changes in the supervisory and legislative framework introduced in the second half of 1990s. After their completion and full implementation in the Czech Republic the International Atomic Energy Agency were requested to independently assess results of the said efforts. The assessment was performed by two international expert IRRT's (International Regulatory Review Teams) missions, which reviewed the SÚJB in January 2000 and in June 2001.

The first review was a reduced-scope inspection mission focusing mainly on SÚJB activities relating to the licensing procedure for Temelín NPP. The inspection team drew the following

conclusions from the mission:

- there is a clearly defined legislative framework in place for Temelín NPP licensing and the SÚJB is required to issue a license for each defined key stage throughout the construction and acceptance period;
- the SÚJB has established requirements as the state regulatory body in respect to the level of nuclear safety assurance at Temelín NPP and has adopted a flexible approach to assure that the adopted inspection and assessment criteria are fulfilled;
- the SÚJB has a previously established plan of inspections applied by its inspectors who check on and confirm that the licensee is commissioning the plant in agreement with the conditions specified in the respective licenses;
- experience and assistance of regulatory bodies from West European countries and the USA have been employed to develop an appropriate state regulatory system in respect to licensing, supervision, assessment and inspecting of Temelín NPP.

Members of the reviewing team handed over several recommendations to the SÚJB whose implementation might further strengthen performance of the state supervision. All suggestions and recommendations concern the long-term development of the SÚJB and arise from current methodical procedures and the achieved results.

The second mission performed a full-scope review of state supervisory activities in peaceful utilization of nuclear energy and ionizing radiation. Twelve experts from nine countries (Germany, USA, Great Britain, Finland, Slovenia and Switzerland plus observers from Austria and Armenia) carried out a detailed review of all aspects of state supervisory activities performed by the SÚJB under the Atomic Act, including supervision of nuclear safety, radiation protection, emergency planning and transports of radioactive materials. According to the results presented by the experts in a final report from the mission, the experts concluded that both the legislative framework and execution of the state supervision of peaceful utilization of nuclear energy and ionizing radiation were at a very good standard, on par with worldwide accepted practices.

In respect to the position of the regulatory body in the state administration structure, the experts highlighted the fact that the SÚJB was independent not only "de jure" but also "de facto". The experts naturally also worded specific recommendations whose implementation may further increase the standard of supervision in the Czech Republic. The recommendations focused on, for example, emergency preparedness practicing and further development in utilization of probabilistic assessment methods in nuclear safety. It was expressly stated, however, that these recommendations were mostly intended for the long-term development of the SÚJB.

The resulting reports from both IRRT missions have been published on the SÚJB website.

3.2 Statement on the implementation of the obligations concerning Article 8 of the Convention

Independent position of the SÚJB, as a regulatory body within the state administration structure of the Czech Republic, its power and competency, financial and human resources fully conform to Article 8 of the Convention.

Fig. 3-1
Statute of the State Office for Nuclear Safety within the State Administration

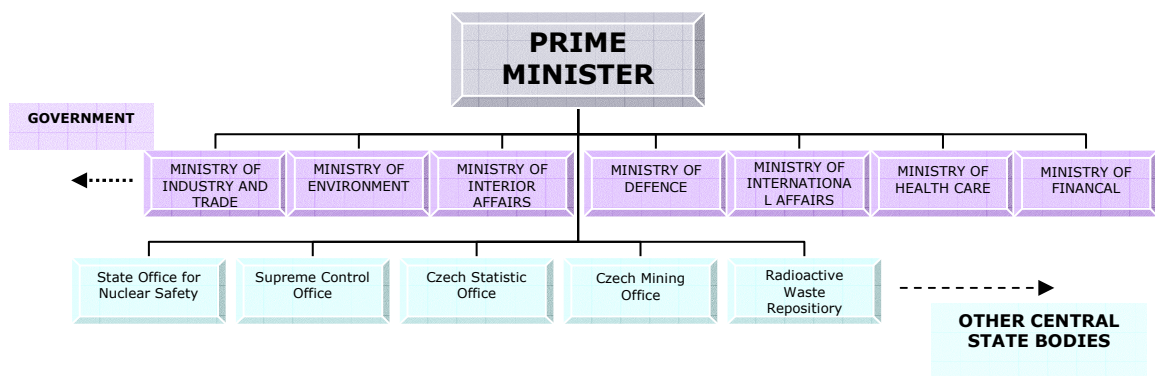
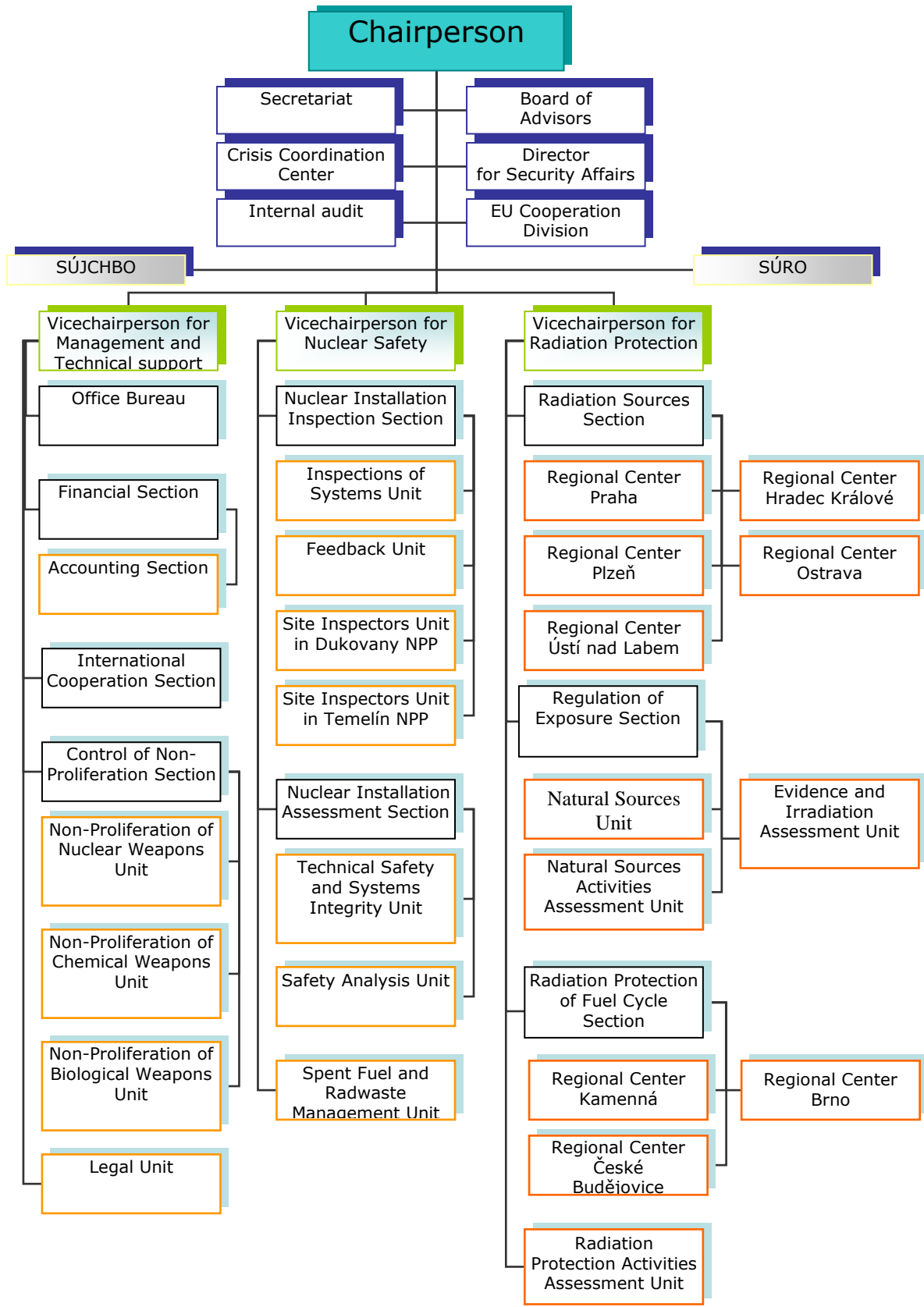

Fig. 3-2 Organizational Chart of the State Office for Nuclear Safety



4. Responsibilities of the Licensee - Article 9 of the Convention

Each Contracting Party shall ensure that prime responsibility for the safety of a nuclear installation rests with the holder of the relevant licence and shall take the appropriate steps to ensure that each such licence holder meets its responsibility.

4.1 Description of the current situation

In accordance with the current legislation of the Czech Republic represented particularly by the Atomic Act, the principle of responsibility of a licensee for nuclear safety of a nuclear installation has been broken down into a number of partial responsibilities, which together represent the over-all responsibility of a licensee for nuclear safety.

These partial responsibilities are specified particularly in Section 17 and Section 18 of the Atomic Act. The basic obligation of the licensee, is to provide for nuclear safety, radiation protection, physical protection and emergency preparedness of its nuclear installation, as defined in paragraph 1, letter a) of Section 17, and technical safety is defined in paragraph 1 letter m) of Section 17. Other provisions subsequently define necessary obligations in respect to the nuclear safety assurance, e.g.:

- systematically assess and maintain nuclear safety and radiation protection, applying the most advanced tools of science and technology,
- comply with technical and organizational conditions of safe operation, with the conditions of the license and approved quality assurance programs,
- investigate, without any delay, any violation of those conditions and take remedial measures and measures preventing repeated occurrence of such situations,
- report, without any delay, about events important for nuclear safety.

One of the main tasks of the state supervision of nuclear safety is monitoring of fulfillment of and adherence to the above-mentioned requirements. The rights of inspectors of nuclear safety and radiation protection are defined, as mentioned above, in Section 39 of the Atomic Act. In agreement therewith, the inspectors check on compliance with the requirements for and conditions of nuclear safety, radiation protection, physical protection, emergency preparedness and technical safety and inspect the nuclear installation conditions, adherence to the Limits and Conditions and operating procedures and demand evidence of fulfillment of all established obligations.

Dukovany NPP and Temelín NPP are owned by the ČEZ, a. s. company, which has, as a licensee, the primary responsibility for nuclear safety of its nuclear installations. The licensee has its own inspection system in place to check the fulfillment of requirements of the Atomic Act. In accordance with the Quality Assurance Program and other documents of the licensee, the check of observance of the duties laid down in the Atomic Act is ensured.

Based on the system, in case of an event affecting nuclear safety, radiation protection, physical protection, emergency preparedness and technical safety, the events important for nuclear safety are registered and investigated by Licensee, and remedial measures are introduced to prevent their repeated occurrence. The licensee shall immediately communicate these events to the SÚJB for supervision of nuclear safety. Non-significant safety related events are also the subject of investigation and in such cases the investigation results, including the adopted

remedial measures to assure that the events are not repeated, are subsequently transmitted. The whole process is regularly and systematically evaluated and monitored by SÚJB inspectors.

The level of nuclear safety, radiation protection, physical protection and emergency preparedness is continuously assessed using the system of internationally comparable indicators. The safety assurance is also subject to the external independent mission, for example performed by the IAEA and the WANO. Results of these assessments, in which the state supervision does not take part are transmitted and discussed with the SÚJB.

The licensee continuously verifies and updates all documents, which represent the basis and condition for issuance of the license, in particular the Safety Report and safety analyses. These updates are submitted to the SÚJB for appraisal on regular basis.

To assure continuous supervision and complex awareness of the state supervision of nuclear power plants, and to perform the de facto continual inspection activities, personnel of the state supervision of nuclear safety are permanently present at Dukovany NPP as well as at Temelín NPP – the so-called "resident inspectors".

As a part of cooperation with similar nuclear power plants currently in operation Dukovany NPP has an agreement with the Slovak plants – Bohunice NPP and Mochovce NPP. Based on the agreement there a periodic exchange of experience and knowledge associated with operational audits is performed by the partners, similar to the WANO Peer Review, or the OSART.

Another important obligation of the licensee mentioned in the Atomic Act is their liability for nuclear damage caused by operation of their nuclear installations (Section 33 of the Atomic Act).

4.2 Statement on the implementation of the obligations concerning Article 9 of the Convention

Current legal provisions dealing with the basic responsibility of licensees for nuclear safety in their nuclear facilities are defined in accordance with the requirements introduced in Article 9 of the Convention.

5. Priority to Safety - Article 10 of the Convention

Each Contracting Party shall take appropriate steps to ensure that all organizations engaged in activities directly related to nuclear installations shall establish policies that give due priority to nuclear safety.

5.1 Description of the current situation

5.1.1 Principle of priority to nuclear safety in the Czech legislation

The principle of priority to nuclear safety has been incorporated into the Atomic Act. Chapter two of this Act establishes general conditions for the performance of activities related to the utilization of nuclear energy. Section 4, paragraph 3 of the Act unequivocally establishes that:

"Whoever performs practices related to nuclear energy utilization or radiation practices shall proceed in such a manner that nuclear safety and radiation protection are ensured as a matter of priority."

The above-quoted principle is contained in all legal regulations, which are related to the Atomic Act in the Czech legal system and break down into details its basic requirements (see chapter 2).

5.1.2 Implementation of principles established in the legislation

ČEZ, a. s. strategy in the area of nuclear safety, priority to the safety principle, safety culture

In accordance with the valid legislation as well as the international obligations of the Czech Republic, the ČEZ, a. s. company accepts responsibility for safety assurance at its nuclear power plants, personnel and public protection, and environmental protection. In order to fulfill this responsibility, the company undertook to create and further develop conditions with sufficient human and financial sources, effective management structure and control mechanisms.

Safety requirements for nuclear installations are given top priority in the company and these requirements exercise decisive influence on all its commercially strategic priorities and main objectives (long-term as well as short-term) focused on operationally safe and reliable power and heat generation.

Safety strategy adopted in the ČEZ, a.s. company focuses on continuous fulfillment of basic safety goals and nuclear safety principles (included in the internal control documents of the company in accordance with the international standards, experience and recommendations and in accordance with the valid legislation of the Czech Republic) with maximum use of safety culture principles and quality assurance requirements. To achieve the strategy goals, all employees were and still are acquainted with this strategy in detail.

Organizational changes implemented in the past year in the ČEZ, a. s. company made a contribution to update of general conditions for fulfillment of the above mentioned safety obligations (strategic goals) as defined and declared by the company through the Safety and Environmental Protection Policy, and the Safety Policy of the ČEZ, a. s., and re-declared by the company in 2006 as Decision made by the management of the company.

The above mentioned obligation on superior position of safety and environmental protection requirements over requirements of production and its operational time schedules is completed by 13 other obligations. In 2006, the ČEZ, a. s. company created the Action Plan for Safety Culture Tasks resulting from the assessment of results of extensive survey implemented in 2005 and fulfils thus another obligation of the Policy, where the company seeks a continuous enhancement of safety culture as an integral part of the company culture.

The rules "Safety and Protection" and the directive "Safety Management of ČEZ, a. s." define the basic scope of powers and responsibilities as well as the method, in which the activities carried out to meet all safety obligations within the company are ensured. Both linked control documents process-describe the mechanism of activity management in the areas of performance of activities important from nuclear safety point of view.

One of the tools for systematic assessment of the level of nuclear safety is a set of indicators, which characterize trends of the nuclear safety level and the radiation protection level in nuclear power plants during the past week, month, year. Through the regular evaluation safety reports, the company's managers thus obtain the feedback for assessment of safety requirement implementation success-rate.

To solve the most significant (principal) safety issues related to the operation of nuclear installations, advisory bodies of Managing Director and Production Manager operate on the top management levels of the ČEZ, a. s. company. Selected representatives of the decisive special departments and joint sections of the company as well as invited specialists and visitors work in the advisory bodies (Committee on the Safety of the ČEZ, a. s. Nuclear Installations and Committee on the Production Section Safety). The basic function is to evaluate the safety level of nuclear installations and to identify the topical and potential safety related problems together with their assessment and subsequent recommendation for optimal solution proposals.

The ČEZ, a. s. company has implemented a progressive restructuring program aimed at improving the control level and making the economics of the plants operation more effective with the current requirement on keeping the minimum same safety level. This process, affecting significantly the organizational and personnel areas, proceeds in a controlled way further to an exhaustive analysis and assessment of possible impact of the prepared change on the operation safety.

A separate complex assessment has been developed for each planned change (according to requirements of the "Assessment of the Organizational Changes Impact on the Safety Level" methodology). The proposed changes (their safety related assessment) are submitted to the state regulatory body for appraisal before their implementation. All approved implemented changes are always subjected to an exhaustive safety related analysis in the specified intervals.

Supervision of nuclear safety

The Atomic Act defining the "priority to safety" principle represents for SÚJB a basic legal document for the performance of the state supervision of nuclear safety and radiation protection. As described in Chapter 3, all SÚJB activities, its organizational structure and work procedures are governed by the said principle. The independent position of the SÚJB within the state administration, as well as the fact that it is funded directly from the state budget, sufficiently guarantee its main purpose.

Within the scope of its authority and competence, the SÚJB performs checks on observation of the "priority to safety" principle, as established by the Atomic Act, in the course of all activities related to the utilization of nuclear energy and performed by other subjects. All organizations which participate in design, manufacturing, construction and operation of nuclear power plants are subject to SÚJB inspections, which assess especially the management approach to safety related issues and how individuals performing safety related activities are motivated in respect to this issue.

5.1.3 Communication with the general public

The ČEZ, a. s. company has been making substantial efforts on a long-term basis to establish friendly and mutually beneficial relationships with the towns, municipalities and population in the vicinity of the power plants. These relationships are based on mutual confidence and honesty, and the public has thus the opportunity to make sure of fulfillment of safety priority during operation of nuclear power plants in the Czech Republic.

Dukovany NPP – Communication with the general public

In the region of Dukovany NPP, representatives and residents of municipalities living in the plant's vicinity and the general public have been allowed to inspect the plants premises, including both storage facilities of spent nuclear fuel, their questions and comments have been answered.

Important tools in this effort are as follows:

- An Information Center of the plant visited by nearly 30,000 people each year, including those coming from abroad and systematic cooperation between the plant and basic and secondary schools and universities.
- A Civil Safety Commission, made up of qualified and trained mayors, representatives and citizens of local municipalities, who receive regular daily reports of SI-EDU and who are authorized to independently inspect the nuclear power plants and inform the general public.
- The ČEZ, a. s., Dukovany NPP and Civil Safety Commission websites are also available.
- There is also the "Zpravodaj" bulletin informing the population in the region about the latest news from the plant and distributed in 40,000 copies to all households within 20 km from the plant.
- The establishing and strengthening of mutual relationships between the plant and its vicinity includes a substantial financial support to municipalities to improve their living conditions and support of various social organizations and institutions through donations and advertising activities.
- Cooperation with emergency units of the country of Lower Austria neighboring to the region of Dukovany NPP is oriented on immediate foreign countries. Representatives on both sides of the border participate in their emergency exercises of either party.

Reliable operation of Dukovany NPP and the above mentioned activities bring the expected result. Support of long-term operation of Dukovany NPP on the part of the population within 20 km from the plant increased from 45 % in early 1990s to current 87 % in 2006. This situation is one of the important political conditions of further operation of the power plant.

Temelín NPP – Communication with the general public

Important group exchanging information on an intensive basis is made up of mayors of 32 municipalities within 13 km of emergency planning zone around Temelín NPP. Apart from personal contacts, the power plant organizes annually 5-6 working meetings with the mayors in the presence of power plant and ČEZ, a. s. company management. At the meetings, the mayors acquire information on operation of units, their safety or power plant plans for further period. A part of the communication with elected representatives includes visits of power plant premises and the ČEZ, a. s. company organizes, 1-2 a year, orientation tours to other nuclear installations both in the Czech Republic and in Europe. The communication with elected representatives of the South Bohemian region is carried out in a similar way.

The Information Center of Temelín NPP, which has been operating since 1991 and which moved to renovated little castle Vysoký Hrádek in 1997, is used to inform the general public and especially schools. Modern methods of presentation such as 3D projection, interactive models, etc. are used therein. Technical equipment in the Information Center enables preparation of "tailor-made" programs for individual groups of visitors. The Information Center is visited by about 25,000 people each year, when every tenth visitor is coming from abroad.

The Prime Ministers of the Czech Republic and Austria concluded A completely super-general agreement on the exchange of information between both states in the matter of Temelín operation was concluded between the Prime Ministers of the Czech Republic and Austria in December 2000 in Melk. A number of expert negotiations took place on the basis of this agreement and Temelín NPP also sends daily reports on its operation to the Austrian party, which are presented in Czech, English and German language also on the ČEZ a. s. website – www.cez.cz.

The "Temelínky" magazine has been issued for fifteen years; the run of press amounts currently to 23,000 copies and is issued six times a year. This magazine is distributed into every household of 32 municipalities within the emergency planning zone. A calendar of emergency preparedness has been issued since 2000 and the population within the vicinity of the power plant receives the plant's booklet containing behavior instructions in the case of emergency situation at the power plant.

Media representatives are provided with daily information on the operation, and briefings with journalists and press conferences are organized in the matter of important subjects. Enabling direct press coverage from the power plant is communication method that is used very often. There are thirty press inspections held each year at a minimum. Daily communication, especially with the representatives of regional newspaper offices, is provided by the spokesperson.

5.2 Statement on the implementation of the obligations concerning Article 10 of the Convention

The principle of priority to safety, as established in Article 10 of the Convention, has been complied with in the Czech Republic.

6. Financial and Human Resources - Article 11 of the Convention

- 1. Each Contracting Party shall take appropriate steps to ensure that adequate financial resources are available to support the safety of each nuclear installation throughout its life.*
- 2. Each Contracting Party shall take appropriate steps to ensure that sufficient numbers of qualified staff with appropriate education, training and retraining are available for all safety-related activities in or for each nuclear installation, throughout its life.*

6.1 Description of the current situation

6.1.1 Financial provision of nuclear safety enhancement at nuclear installations in the course of their operation

The Atomic Act establishes as one of the general conditions that any person performing or providing for practices related to nuclear energy utilization, shall have an implemented quality assurance system to the extent and in the manner set out in an implementing regulation (Section 4 paragraph 8). This is the SÚJB Decree No. 214/1997 Coll., on quality assurance in activities related to the utilization of nuclear energy and in radiation practices, and laying down criteria for the assignment and categorization of classified equipment into safety classes. Quality Assurance Programs for the activities being licensed shall be approved by the SÚJB.

Documentation of the licensee's – ČEZ, a. s. – quality assurance system includes the commitment to arrange for sufficient financial resources available for assurance of the safe operation of the company's nuclear power plants. This commitment is included in the company's Organization Rules. In connection with the ČEZ, a. s. Safety and Quality Assurance Policy, the provision of sufficient resources for assurance of nuclear safety and personnel protection as well as environmental protection has been described in detail in the relevant control documents.

Safety maintenance and enhancement in the NPPs operated by ČEZ, a. s. is performed in the controlled manner in accordance with the elaborated regulations and programs. On their bases the business plans are developed which are subject to approval on the management of the production section and ČEZ, a. s. management level. Further the individual projects are incorporated into the investment budgets of the company for the corresponding year. Funding of the individual projects is provided from the company's unrestricted sources.

6.1.2 Provisions for assurance of financial and human resources for the decommissioning of nuclear installations and management of radioactive waste generated during their operation

Radioactive waste

The management of radioactive wastes, including those generated at nuclear power installations, is regulated by Section four of the Atomic Act (Sections 24 – 31). The Section 24 stipulates:

"An owner of radioactive waste or other natural person or legal person managing the assets of an owner in such a manner that radioactive waste is generated (hereinafter referred to as "generator") shall bear all costs associated with its management, from its time of origin to its disposal, including monitoring of radioactive waste repositories after their closure, and including the necessary research and development activities."

Further, the Section 25 of the Atomic Act establishes as follows:

"Under the terms of this Act, the State guarantees safe disposal of all radioactive waste, including monitoring and supervision of repositories after their closure."

Financial means to be used to cover costs of radioactive waste and spent fuel disposal are, in accordance with the Atomic Act, deposited by the waste generators to a Nuclear Account opened at the Czech National Bank. The Nuclear Account is administered by the Ministry of Finance, its means are part of the state financial assets and liabilities, and the utilization of which is decided by the government in accordance with the Act No. 218/2000 Coll., on budgetary rules, as amended.

The funds on the nuclear account may only be used for the purposes specified by the Atomic Act. The amount and method of payments to the nuclear account are decided and specified by the Czech government, based on a proposal submitted by the Ministry of Industry and Trade. The Radioactive Waste Repository Authority (SÚRAO) is founded in agreement with the Atomic Act by the Ministry of Industry and Trade to carry out activities related to radioactive waste disposal. Activities of the Radioactive Waste Repository Authority are funded by means of the Nuclear Account and its annual budget shall be approved by the government.

The radioactive waste management (as well as that of non-active waste, decontamination and technical issues of decommissioning) at ČEZ, a. s. company's nuclear power plants is controlled by independent organizational departments within the safety and technical support section (i.e. outside the production section). The training of personnel is carried out within the framework of a uniform training system (see also chapter 7.1.3).

Decommissioning

The basic obligations of a licensee as specified in Section 18, paragraph 1, letter h) of the Atomic Act include the obligation to evenly create financial reserves for the preparation and actual decommissioning of nuclear installations. The amount of this reserve shall be established based on the decommissioning technology approved by the SÚJB and based on the estimate of the costs for given decommissioning technology verified by Radioactive Waste Repository Authority. The method of creating reserves is governed by a separate legal regulation issued by the Ministry of Industry and Trade of the Czech Republic. The creation of reserves is controlled by Radioactive Waste Repository Authority. Currently, proposals for the decommissioning method have already been approved for the Dukovany NPP and the Temelín NPP. The corresponding financial reserves are created in accordance with the legal regulations for both nuclear power plants operated by the ČEZ, a. s.

The ČEZ, a. s. decommissioning documentation is being prepared by a multi-professional team, consisting of experts from the Nuclear Power Division, whose knowledge and experience may be used during the decommissioning preparation. From the organization viewpoint the team is made up of representatives from the Economics section, Production section and Safety section. The team deals with technical, financial, investment and organizational issues of the decommissioning, including provision of the appropriate human resources. Appointing of the team and all activities carried out in this area, have been in

compliance with the quality assurance requirements adopted by ČEZ, a. s. and established in the quality assurance program for nuclear activities.

Insurance

The Czech Republic joined the Vienna Convention on Civil Liability for Nuclear Damage and Joint Protocol relating to the Application of the Vienna and Paris Conventions in 1995 (declared in the Collection of Laws under No. 133/1994 Coll.).

These issues were covered by a governmental statement (guarantee) within 1994-1997. In 1997 the Atomic Act came into effect establishing the liability of operators of nuclear installations for damages and charging them with the obligation to obtain insurance (Sections 32-38). The liability of operator of major nuclear installations has been set down by the Act at 6 billion CZK (about 215 million euro). The operator is obliged take out liability insurance for nuclear damage caused by the nuclear installation operation at the minimum of 1.5 billion CZK (about 53.5 million euro).

The insurer for nuclear risks in the Czech Republic is the Czech Nuclear Pool in association with the most significant insurance companies acting on the Czech insurance market. This pool is a member of the international association – Nuclear Pools Forum. Based on inspections performed by international insurance pools both Czech nuclear power plants have been insured for the liability in accordance with the Atomic Act as well as for property: Dukovany NPP since 1997 and Temelín NPP since 2000.

The Czech Republic, a pro-active participant in international negotiations in this area, signed on June 18, 1998 the Protocol to Amend the Vienna Convention on Civil Liability for Nuclear Damage and also the new Convention on Supplementary Compensation for Nuclear Damage. The Czech Republic has not so far ratified these international instruments.

6.1.3 Rules, regulations and provision of resources for qualification, basic training and regular training (including simulator training) of the personnel whose activities have impact on nuclear power installations safety

Legislation

The Atomic Act sets forth conditions under which nuclear energy and ionizing radiation may be utilized. The Section 17, paragraph 1, letter i) of the Atomic Act introduces the following general obligation to the licensee:

"entrust performance of the specified activities only to such persons who fulfil conditions of special professional competence and are physically and mentally sound".

According to Section 18, paragraph 1 the licensee is also obliged to: *"provide a system of training and verification of competence of personnel in accordance with the importance of the work they perform".*

Preconditions for performance of activities directly influencing nuclear safety are established by the provision of Section 18, paragraph 3 of the Atomic Act. Such activities may only be performed by persons, who are physically and mentally fit, with professional competence verified by the State Examining Board and to whom the SÚJB has granted an authorization for the concerned activities, upon an application by the licensee.

Professional training of the selected personnel of nuclear installations may, according to Section 9, paragraph 1, letter n) of the Atomic Act, be organized by a physical or legal entity

only based on a respective license granted by the SÚJB. Documentation required for the issuance of such a license is listed in an Appendix to the Atomic Act.

The SÚJB Decree No. 146/1997 Coll., as amended, in compliance with the quoted provisions of the Atomic Act, specifies activities with immediate impact on nuclear safety and activities particularly important for radiation protection, requirements for qualification and professional training, method of verification of special professional competence and authorization process of the selected personnel, as well as the format of required documents to obtain a license for training of selected personnel.

The above-mentioned legal regulations have been complemented with the Safety Guide BN 01.1 [6-1] issued in April 1994 by the SÚJB, covering professional education and training of personnel for the performance of work activities (positions) at Czech nuclear installations. The Guide specifies criteria and provides methodical guidelines for management and execution of training of employees of nuclear installation operators and employees of legal and physical entities whose activities (positions) at nuclear installations are important for nuclear safety, with the objective to minimize risks caused by human failure.

The SÚJB Decree No. 193/2005 Coll., establishes the list of theoretical and practical fields of knowledge that is contained in the education and training required in the Czech Republic for the performance of controlled activities falling within the authority of SÚJB.

Application of legislative requirements to the holders of licenses for operation or construction of nuclear installations

The only guarantor of personnel training, from the Atomic Act viewpoint, within the ČEZ, a. s. is the NPP Training section, which is a part of the Human Resources Development section within the Human Resources division. The main purpose of this section is to perform professional training of personnel for both power plants as well as for external suppliers. The section is also, in accordance with the internal control documents, responsible for the establishing of a concept, strategy and system of professional training of personnel for all nuclear activities in the ČEZ, a. s.

Within the meaning of personnel training the activities are carried out in three training and educational centers (at Brno, Dukovany NPP and Temelín NPP locations), which are incorporated in the NPP Training section in terms of organization.

The respective managers at all management levels are responsible for the professional competence (qualification) of their subordinates. Principles governing the process of personnel professional training in respect to nuclear activities are described in the control document "Assurance of competence for performance of activities in the nuclear installation".

The Preparation and Training section, as a guarantor of the process, permanently keeps, in accordance with the provision of Section 9, paragraph 1, letter n) of the Atomic Act, the validity of the SÚJB license for the training of nuclear installations personnel as well as of selected personnel of workplaces with ionizing sources.

The concept of qualified personnel training of ČEZ, a. s.

The objective of personnel training is to assure that each individual of nuclear power plant possesses necessary knowledge, skills and habits required for achieving, maintaining and developing the relevant professional competence. The fulfillment of this objective is verified by examinations and, for selected functions, formally confirmed by authorizations issued by the employer to perform the concerned activities. For each position the requirements for

education, professional experience, health and psychical fitness, probity and especially for continued professional training of the personnel, before they start to perform their respective activities are established.

The personnel training system at the NPP is closely related to the system of education in the Czech Republic. A significant proportion of employees are university graduates or technical high school graduates. For this reason the training process at the nuclear power plant focuses on provision of additional special knowledge in the area of nuclear instalations, acquisition of practical professional knowledge and skills necessary to perform the work concerned. Special attention is paid to the units' main control rooms operators, shift and safety engineers, operation and inspection physicists (selected personnel). Their training is always concluded with examinations before the State Examining Board (for more details on the State Examining Board see Chapter 7).

The *personnel training* as a process consists of *specific training* (which is further divided into *basic training* and *regular training*) and *professional training*.

The process of personnel training starts with recruitment and hiring. New workers are always selected according to the criteria established in the internal instruction "Personnel Searching Selection and Adaptation". The selection process includes verification of health and psychic fitness of the employees for their future positions.

The training consists of professional and effective training of NPP personnel and suppliers. The responsible department puts the personnel training system into practice, implements this system and evaluates the given process. The department is fully responsible for application of new training techniques and means in order to improve the efficiency of personnel training.

The Professional Training section administers the central files of personnel qualification maintained for each work activity performed at all departments of the nuclear power plant.

Basic, periodic and professional training of personnel of ČEZ, a. s.

The purpose of *basic training* is to acquire or to improve specific professional capability necessary for performance of a given work activity. The basic training is obligatory for each employee who performs a work activity important for nuclear safety or radiation protection. The basic training shall be provided to all new employees and to the employees trained for different work.

The employees are assigned to one of the training groups according to their work activity and professional specialization. From the viewpoint of nuclear safety the five following groups are defined, for:

- management,
- selected personnel,
- employees of engineering departments,
- shift and non-shift operating personnel,
- maintenance personnel.

From the viewpoint of radiation protection, three groups are defined in agreement with the SÚJB Decree No. 307/2002 Coll., on radiation protection:

- selected personnel,
- radiological personnel,
- other employees.

Training is carried out in compliance with the approved training programs prepared by the nuclear power plant in cooperation with the training guarantor (Preparation section). There are the following forms of basic training, depending on the training program, training group, specialization and requirements of the qualification standard/schedule:

- theoretical/classroom training,
- secondment at the nuclear power plant,
- training on a full-scale simulator,
- examination to obtain a Certificate,
- training for a specific position,
- examination to obtain an Authorization,
- Authorization for a work activity.

The individual mutually linked-up parts of theoretical and practical training are combined into modules, and the whole duration of the basic training varies from 6 to 90 weeks, depending on the type of work to be performed after training.

Periodic training serves to maintain, update or deepen specific professional competence of an employee as required to carry out his/her work. Each employee who performs an activity important for nuclear safety or radiation protection is obliged to undergo periodic training.

There are the following forms of periodic training, depending on the training program, training group, specialization and requirements of the qualification schedule:

- theoretical/classroom training (training days, training dealing with industrial safety, fire protection, emergency preparedness, access to controlled area, etc.),
- training on a full-scale simulator,
- training and examination to obtain Authorization.

Duration of the individual forms of the periodic training varies from several hours to two weeks (for the simulator), depending on the type of work to be performed after training.

The purpose of *professional training* is to maintain, update, deepen or improve the specific professional competence of an employee as required to carry out his/her work. Each employee whose work involves nuclear installations is obliged to undergo the professional training. The exposure to professional training is very important for employees who perform activities important for nuclear safety or radiation protection since the training represents a precondition for continuing validity of the Authorization. Duration of this form of training depends on the type of work activity and may be carried out as a one-off training or long-term course.

Training of Dukovany NPP personnel at a simulator

A full-scale simulator VVER 440 is used for basic and periodic training of Dukovany NPP personnel – a replica of the main control room situated at the power plant site.

The replica-type simulator is a high-fidelity copy of the operating personnel workplace in the main control room, with all counters and operating panels, including all instrumentation and information system screens placed therein. The simulation of technology, technological processes as well as the control and management system is performed on a modern system based on SILICON GRAPHICS computers using simulation software supplied by the GSE and OSC companies.

The simulator also includes a separate workplace for the instructors, with the so-called

instructors station, from which the instructors control the simulator and manage the training (set-up the initial reactor condition, enter defects of the equipment and on operator's request simulate manipulations performed on the real unit by the operating personnel etc.). Communication between the training main control room staff and the instructor is via a closed circuit telephone line. The installation enables the instructor to listen to the main control room personnel and to record their actions with a camera recording system.

Further there is a display version of the simulator to be used for training, which displays results of the computing model of the main control room in a virtual form on the monitors. Within the project for I&C system renovation both simulator models are modified and the training tool for reorientation training of the operating personnel is thus developed for the newly implemented I&C systems.

Training of Temelín NPP personnel at a simulator

The concept of training provided to the qualified personnel at Temelín NPP essentially follows the pattern used at Dukovany NPP.

The training of Temelín NPP personnel is performed at a full-scale VVER 1000 simulator on the site.

The workplace of operators has been designed identically with the real main control room and the construction part of the simulator hall has been adjusted accordingly. The simulation of technology and technological processes is performed on a modern system based on SILICON GRAPHICS computers. The information and control system of the simulator for operators is a customized WDPF system supplied by the WESTINGHOUSE Company. This company also supplied counters and panels, including instrumentation, for the full-scale simulator; identical counters and panels are used in the main control room.

As with the VVER 440 simulator, training on this simulator is managed by the instructors and the communication and recording equipment is included.

A display version of the VVER 1000 simulator has also been developed at the Temelín site, which is currently used both for training and for engineering purposes.

Organization and provision of training at simulators

The operating personnel training at simulator runs according to the time schedule harmonized with the operations needs in accordance with the programs approved by the SÚJB, including examinations at the simulator.

Training instructors at the simulator at both sites are highly qualified personnel of the Preparation section having experience as a reactor unit manager and supplementary educational knowledge.

Scenarios of all training activities in the given course are prepared, tested and approved for training implementation. The scenarios cover the following operating modes of the power plant reactor building technology:

- unit start-up from cold state to nominal power,
- unit operation at various power output levels,
- unit shutdown from the nominal power to cold state,
- liquidation of error conditions of the unit,
- liquidation of emergency conditions of the unit.

The scenario contains objectives of the training description of the unit's initial state, expected procedure of the personnel when solving tasks, methods to simulate tasks and success-rate criteria. In addition, in case of basic training the scenario contains theoretical analysis. Valid operating procedures are available at the personnel workplace to solve tasks to the same extent as in the real main control room.

When using simulators the main focus of attention is on the simulator-based training of Dukovany NPP and Temelín NPP personnel, however, the simulators are also used for training of personnel of the Technical Support Centers as well as of other personnel of operating and technical departments.

Simulators are also successfully used for validation of operating procedures, preparation of tests as well as for other analytic activities.

Professional training provided to employees of external suppliers

The process of personnel training in the case of employees of external suppliers is, as well as that of the plant's own personnel, comprised of basic, periodic a professional training. Requirements for the professional competence of external personnel depend on the ČEZ, a. s. needs for providing activities, especially activities related to maintenance and repair of the equipment. The system is based on fundamental assurance of professional qualifications by the supplier, completion of professional training in accordance with the ČEZ, a. s. requirements

Types of training obligatory for individual employees are established by relevant international recommendations. Detailed requirements for each type of training are specified in the internal control documents. The external suppliers are required to have their training system and qualification assurance described in their own documents, including a method to prove fulfillment of requirements for the professional competence.

Evaluation of training

Evaluation of training and verification of personnel capability is a precondition needed to establish efficiency and effectiveness of the training programs used for individual forms, stages and types of training. Results of such evaluations provide a feedback through which the contents and scope of the professional training are modified aimed at improving its effectiveness. The basic information sources used for a systematic evaluation of the professional training include direct verification of personnel knowledge and evaluation of the standard of training processes by managers, trainees and instructors.

6.2 Statement on the implementation of the obligations concerning Article 11 of the Convention

The provision of financial and human resources for nuclear safety assurance in the Czech Republic is in compliance with the requirements established in Article 11 of the Convention.

7. Human Factors - Article 12 of the Convention

Each Contracting Party shall take the appropriate steps to ensure that the capabilities and limitations of human performance are taken into account throughout the life of a nuclear installation.

7.1 Description of the current situation

7.1.1 Methods for prevention, determination and correction of human errors

Legislative requirements

The Atomic Act establishes in Section 17, paragraph 1, letter b), as one of the general obligations of a licensee, the obligation to:

"assess in a systematic and comprehensive manner the fulfillment of conditions set in Section 4, from the aspect of the current level of science and technology, and ensure that the assessment results are put into practice".

This requirement of the Atomic Act is further specified in the SÚJB Decree No. 106/1998 Coll., on nuclear safety and radiation protection assurance during commissioning and operation of nuclear facilities, in which the Section 14 imposes upon the licensees the obligation to review and modify the operating procedures so that they conform to the current level of science and technology, and at the same time reflect the operational experience and practice. The assessment of human factor impacts on operation safety is one of the basic components of the process.

Assessment of human factor impact at Temelín NPP and Dukovany NPP

The monitoring of human factor impact on the occurrence and development of operational events is performed by the Temelín NPP and Dukovany NPP Nuclear Safety departments and is in accordance with the relevant common control documentation valid in both NPPs. The human factor is understood as a significant safety element and permanent attention is paid to its possible failure. The purpose of human factor evaluation is to assess the level of various human behavior impacts on performance of activities related to technological process as well as on safe operation of the nuclear power plant. The importance of the human factor as a significant matter in safety is taken into account in the methodology of the evaluation of operational events and their importance according to the INES international scale.

The results of regular assessments of operational events in individual nuclear power plants have proven that a significant proportion of these events were caused by one or another form of human failure, either directly, and operator's error during performance of particular activity or human failure in other fields (documentation, design, etc.).

To investigate the causes of human failure impact on the occurrence and development of operational events the nuclear power plants apply the internationally recommended ASSET (Assessment of Safety Significant Events) and HPES (Human Performance Enhancement System) methodologies. Direct and root causes of the individual events are classified as equipment failures, documentation deficiency or humane error. In case the human factor impact is identified during the determination of causes, detailed investigation takes place in

individual NPPs, resulting in elaboration of human factor impact analysis for the respective event. This analysis is an integral part of the overall analysis of the respective operational event.

Employees involved in the investigation of causes of human failure have been trained in the ASSET and HPES methodologies. Human factor impact is monitored within all NPP departments, however, the maximum emphasis is put on monitoring of human factor in respect to the shift operating personnel.

The causes of human failure are assessed and confirmed by the Failure Commission at the plant (each NPP has its own Commission). Based on the respective analysis corrective measures are imposed aimed at effectively ensuring that the same deficiencies in human behavior do not repeat thus eliminating repetitive events.

One of the means for human failures prevention are training days regularly organized for selected categories of the NPP personnel. These training days include information on selected operational events, based on specialization of the trained personnel and with regard to the cases of human failure.

Obligatory psychological examination is applied for selection of personnel with the minimum risk of failures caused by carelessness or negligence.

To minimize the human factor impact in the course of performing activities the NPP has been continuously developing a system of operating procedures to guide each operator and warn about potential risks, while providing absolutely unambiguous description of activities. Selected manipulations are described in the form of check-lists. When setting the safety systems into the emergency mode the method of independent inspection is applied.

Human failure causes, including evaluation of trends of human factor impact, are in both NPPs regularly evaluated in the annual reports on operational events, together with factors contributing to human failure.

7.1.2 Role of the regulatory body in the human factor assessment

SÚJB also systematically monitors the impact of human performance on the operational safety. Conclusions of the plant's so-called "Failure Commission" are discussed at regular meetings. In this respect, the SÚJB particularly reviews whether the events with contribution of human erroneous actions were investigated in sufficient detail, whether corrective actions address determined causes so that recurrence of the events is prevented and whether such corrective actions are implemented in the proper and timely manner. In particular cases, a special inspection related directly to a certain event with significant contribution of human erroneous actions can be carried out. SÚJB further evaluates separate reports sent on an annual basis, which include the trend analysis of events with contribution of human and organizational factors by selected aspects.

In 2005, the SÚJB announced, within its Research and Development Program, a project "Methodology of Human Factor Assessment in Operation of Nuclear Installations". The main objective of the project was to provide SÚJB staff with guidelines for analysis of problems related to human factors in connection with operational safety of nuclear installations in the Czech Republic. The proposed procedures use recent knowledge in the field and observe the operational particulars of nuclear installations. Project outputs include the methodology for operational events evaluation in connection with performance shaping factors, the methodology for organizational factor analysis, and they make account of management role in

assuring safe operation of nuclear installations with special focus on management of change. Methodologies apply also probabilistic approach (HRA) which is dealt with at SÚJB by a special-purpose group.

A system of verification of special professional capability for selected personnel of nuclear installations is instrumental in the prevention of human error occurrence. In accordance with the Atomic Act (see SÚJB competence in chapter 3.1) the SÚJB shall establish for this purpose a state examining board and identifies activities with immediate impact on nuclear safety. Verification is carried out in form of an exam before the state examining board.

This exam consists of examination at a simulator, theoretical written and oral part, and a practical part, including examination at a simulator. The state examining board may decide to skip the practical part or to allow the so-called integrated test (oral examination is directly linked to examination at a simulator) in the case of authorization renewal. A failed exam may be repeated by the applicant within a 1 - 6 months period whereby the specific date shall be determined by the state examining board. Under a respective implementing regulation an individual who has successfully passed the exam in front of the state examining board is granted a selected personnel authorization by the SÚJB for a period of 2 to 8 years.

7.2 Statement on the implementation of the obligations concerning Article 12 of the Convention

The requirements under Article 12 of the Convention, on evaluation of possible human factor impact on operational safety over the whole service life of nuclear installations, are complied with in the Czech Republic.

8. Quality Assurance - Article 13 of the Convention

Each Contracting Party shall take the appropriate steps to ensure that quality assurance programmes are established and implemented with a view to providing confidence that specified requirements for all activities important to nuclear safety are satisfied throughout the life of a nuclear installation.

8.1 Description of the current situation

8.1.1 Quality assurance legislation

The Atomic Act establishes general conditions for the performance of activities related to the utilization of nuclear energy, radiation practices and actions to reduce radiation exposure. The provisions of Section 4 paragraph 8 establishes as follows:

"Any person performing or providing for practices related to nuclear energy utilization or radiation practice, except the activities according to Section 2 letter a) paragraphs 5 and 6, must have an implemented quality assurance system, to the extent and in the manner set out in an implementing regulation, aimed at achieving the required quality of a relevant item, including tangible or intangible products, processes or organizational arrangements, with respect to the importance of this item from the aspect of nuclear safety and radiation protection. The implementing regulation shall set basic requirements for quality assurance of classified equipment with respect to their safety classification".

The relevant implementing regulation is in this case SÚJB Decree No. 214/1997 Coll., establishing basic requirements for the quality assurance of classified equipment (items) and on their safety classification, giving details of:

- requirements for the introduction of a quality system covering activities specified by the Atomic Act,
- requirements for such a quality system,
- requirements for the quality assurance of classified equipment (items) in respect to their safety classification,
- requirements for the content of quality assurance programs,
- criteria for classification of classified equipment into safety classes,
- scope and format of the List of Classified Equipments

Pursuant to Section 13, paragraph 5 of the Atomic Act, a license to be issued by SÚJB for specified activities in the utilization of nuclear energy and ionizing radiation shall be conditional upon an approved quality assurance program for the licensed activity (see chapter 3.2.1).

8.1.2 Quality assurance strategy of the licensee - ČEZ, a. s.

The first concept of the new business strategy was approved at the company's general meetings in July 1995.

This document helped to guide the company business, to communicate to the company bodies and employees the idea about the basic focus of the company in a changing business

environment and to create conditions for a sustainable and successful development of the company on a long-term basis. The general meeting of ČEZ, a. s. in June 1999 approved an updated version of the Concept of the Business Activity until 2005, which was based on the company mission: to reliably meet the demands of customers for electric power and related services, while keeping competitive prices and protecting the environment.

In linkage to the integration of REAS (distribution energy joint-stock companies) and ČEZ, a. s. into the ČEZ Group, the top management issued, in 2004, a new strategic frame for 2004 – 2008, the so-called Vision 2008. Therefore, strategic goals by 2008 relate, inter alia, to the field of business activities, geography, brand equity and economic power of the company, and shall meet the mission of the ČEZ, a. s. – maximize return on equity for shareholders.

The goal of the company management strategy is to integrate safety, environment, personnel protection and quality into a uniform management system providing a framework for high reliability, efficiency and credibility of the company management.

In December 2000 the company issued a revised Manual of Nuclear Activities as a general document to replace the following documents issued earlier: Quality Assurance Programs, particularly the Top-level QA Program and the QA Program for Nuclear Activities. The manual also covered the Safety Policy, Environmental Policy and Quality Assurance Policy of ČEZ, a. s., revisions of which were issued by decision of the Board of Directors in 2006. In linkage to the establishment of the Nuclear Power Plant Division, the Manual of Nuclear Activities was superseded in 2004 by the directive Quality Management System. This directive was revised in 2007 and the Quality Management System of ČEZ, a. s. was issued.

ČEZ, a. s. introduced and documented the quality system, taking into account the obligations published in the company's Quality Policy, in order to assure the processes and activities within the scope of the above mentioned nuclear activities. This quality system is designed to carry out the assurance of processes and activities related to nuclear safety in a controlled and organized way, fully within the limits of the Atomic Act and its implementing decrees, including SÚJB Decree No. 214/1997 Coll. The requirements of the quality system are applied in a structured approach according to the relevance of individual processes and items for the nuclear safety and radiation protection.

Further improvement of the quality system was based on the objectives of ČEZ, a. s. management to introduce complex quality control. The improvement focused on the amended ISO standards of the series 9000:2000. The company provides necessary human, material, financial, information and other resources for the introduction and continual improvement of the quality management system.

The quality system currently introduced in the nuclear field, fulfils not only the requirements of the ČSN ISO 9000 set of standards, but also the ISO 14000 set of standards and highly observes IAEA recommendations published in the Safety Series.

An example of the company's approach to the environment are the results achieved by both the NPPs, application of requirements of ISO 14000 series standards into the control system at all plants operated by ČEZ, a. s., including their subsequent certification carried out at Dukovany NPP in 2001 and at Temelín NPP in 2004.

During the period 2000 to 2002 the quality system was gradually rationalized in line with the development of the company ČEZ, a. s.; the activities were redefined. The control tools were modified, especially the system of document control and their creation. Another change of the control system has been in progress since 2005, when ČEZ, a. s. started to optimize and

rationalize its activities in consequence of extension of its authority both at home and on foreign markets. This means, in the area of nuclear activities, to transform the organizational structure of the company, which would, among others, result in integration of the organizational structure of both nuclear power plants (Dukovany NPP and Temelín NPP), while keeping, or improving, the strategic goals within this area. The maintenance and development of safety levels, reliability and protection of personnel as well as the environmental protection, improvement of competitiveness (in terms of costs) and acceptability of nuclear energy by the public, which recently relates to the construction of intermediate storage facilities or spent fuel storage facilities, which are of particular concern.

The problems related to the quality system in the nuclear area are currently integrated into the company management system.

In linkage to optimization and rationalization of activities within ČEZ, a. s. the Production section was established in 2005 as an organizational unit covering production activities of the company. Based on analyses and with a view to use synergic effects, preparation of change in the life span control system of power plants is in progress.

In this connection, with respect to specified basic areas for the activities, a new system of control documentation is being developed. The transfer to a new system of documentary control of the quality system is assured to be continuous and progressive, and to fulfil, in everyway the requirements for quality assurance of activities important from the nuclear safety point of view.

8.1.3 Quality assurance programs for all nuclear installation service life stages

ČEZ, a. s. quality system is described and determined by a system of documentary control. The system of control consists of:

- strategic documents (e.g. Quality Policy, Safety Policy, etc.) - Ist level,
- control documents (rules, directives, procedures, orders from the Director General and the Executive Director) - IInd level,
- working documents (e.g. methodology, operating instructions and technological procedure) - IIIrd level.

Working outputs – records (documentary output, document used for justification, design documentation, drawing, etc.) are an internal part of the documentation of ČEZ, a. s. quality system. Normative documents include the directives and procedures only.

The Quality Assurance Programs are developed by ČEZ, a. s. in order to assure nuclear quality, defining the quality system of the licensee, processes and activities involved, including definition of the responsibilities of the licensee and suppliers. The Quality Assurance Programs have a character of licensing documents using the above-mentioned set of control documents for the definition. The Quality Assurance Programs are elaborated in accordance with the requirements of Section 32 of SÚJB Decree No. 214/1997 Coll., issued by the SÚJB for individual licensed activities within the meaning of Section 9 of the Atomic Act.

Pursuant to the provisions of Section 13, paragraph 5 of the Atomic Act the company ČEZ, a. s. has Quality Assurance Programs approved by SÚJB for the licensed activities during the individual stages of nuclear installation service life (see chapter 8.1.5). By now, more than 300 Quality Assurance Programs have been developed and approved mostly for the licensed activities, execution of reconstruction and other changes.

The Quality Assurance Program, related to the operation at Dukovany NPP and Temelin NPP, and combining the programs for five types of licensed activities, i.e. operation of nuclear installation and workplace of category IV; restart-up of a nuclear reactor with criticality introduction after refueling; performance of reconstruction work or other changes affecting nuclear safety, radiation protection, physical protection and emergency preparedness of nuclear installation or workplace of category IV; management of ionizing radiation sources; management of nuclear materials.

This Quality Assurance Program was developed to assure that the requirements specified in the SÚJB Decree No. 214/1997 Coll., on quality assurance in activities related to the utilization of nuclear energy and in radiation practices, laying down criteria for the assignment and categorization of classified equipment into safety classes, were taken into account in the quality system of the licensee. The structure of the Quality Assurance Program is selected in respect to the structure of basic activities determined within ČEZ, a. s. The last revision of this document was approved by the SÚJB decision of January 31, 2007.

The Quality Plans of suppliers of components, systems and services with an influence on the nuclear safety and radiation protection of nuclear facilities relate to the Quality Assurance Program for licensed activities.

8.1.4 Application and evaluation of quality assurance programs efficiency

ČEZ, a. s. has established responsibilities for the control and verification of quality for all processes and at all levels. Responsibilities, in relation to equipment quality and process verification, are described in the relevant documents, which are an integral part of the documented quality system. The Manager for Control and Organization System section is responsible, on this control level, for the development of the quality system and coordination of its implementation, for the monitoring and evaluation of its effectiveness as well as for the improvement of productivity and quality management with the information support for the control of processes and activities, including quality assurance in accordance with the Atomic Act.

Responsibilities for the actual implementation rest with all managers throughout the company. Each employee is responsible for the quality of his/her work. Individuals who perform inspection and verification activities have adequate authority to identify discrepancies and, if necessary, to require remedial measures to be taken. The required level of quality is verified by other employees, who are independent of performed activities. All company employees are encouraged to submit proposals on upgrading and modifying the quality system.

Regular training of the company employees is understood as an investment in quality. A uniform training program for ČEZ employees is used in the area of human resources development. The training program for the management and other employees is based on the ČEZ, a. s. quality concept. The training program is aimed at achieving general understanding of the quality system and all its tools and methods by employees in order to involve them in the process of quality assurance and quality improvement and make them participate in the development, implementation and improvement of the quality system.

The quality system efficiency is assessed for the past calendar year and the system is improved in the course of the current calendar year. Managers at all levels periodically evaluate all processes and procedures within their responsibility with the objective to review their actual condition and efficiency.

External audits of the quality systems of the suppliers as well as internal audits, performed by qualified auditors in accordance with the written procedures, represent an important part of the company's inspection system. Company managers use the results of the quality audits to take necessary corrective, preventive and remedial measures.

8.1.5 Current quality assurance practices applied by the state regulatory body

The SÚJB, in accordance with Section 39 of the Atomic Act, checks compliance by the licensees with the Atomic Act, including the quality assurance requirements mentioned above. Whenever it is deemed necessary, the inspection activities are extended to include the subcontractor. The inspection activities focus both on the system and on the quality assurance of particular selected systems, structures and components. The SÚJB unit primarily performing this activity is the Section of Nuclear Installation Assessment (see the SÚJB Organizational Chart - Fig. 3-2).

In compliance with the Atomic Act SÚJB approves quality assurance programs for nuclear installations dealing with:

- siting,
- design,
- construction,
- individual stages of commissioning,
- operation,
- start-up after refueling,
- reconstruction and other changes with a potential impact on nuclear safety, radiation protection, physical protection and emergency preparedness,
- decommissioning,
- management of ionizing radiation sources
- radioactive waste management,
- radioactive material management,
- training of selected personnel,
- performance of personal dosimetry and other services important from radiation protection point of view.

In accordance with the Atomic Act an approved quality assurance program is one of the preconditions for the issue of a license for the activities specified in Section 9, paragraph 1 (see chapter 3.1.2). Criteria for the assessment of quality assurance programs are established in SÚJB Decree No. 214/1997 Coll. and other binding regulations and standards.

The SÚJB also approves the List of Selected Systems, Structures and Components , a document listing items important from the viewpoint of nuclear safety, divided into three safety classes in accordance with the criteria specified in Appendices to SÚJB Decree No. 214/1997 Coll., which are in accordance with IAEA criteria.

To issue a license for a nuclear installation siting SÚJB shall consider the following, as part of the Initial Safety Report:

- quality assurance assessment for the siting,
- quality assurance method in the preparation for construction,
- quality assurance principles for the following stages.

To issue a license for the construction of a nuclear installation SÚJB shall consider the following, as part of the Initial Safety Report:

- quality assurance method in the preparation for construction,
- quality assurance method in the construction implementation,
- safety assurance principles for the following stages.

For the approval for first fuel loading, SÚJB shall consider quality evaluation of the selected items, as part of the Pre-Operational (Final) Safety Report.

8.2 Statement on the implementation of the obligations concerning Article 13 of the Convention

The current legislation of the Czech Republic and its practical application guarantee that quality assurance programs are developed and implemented, making sure that all specified requirements for all safety related activities will be fulfilled over the whole period of the service life of a nuclear installation. The requirements specified in Article 13 of the Convention are fully complied with.

9. Safety assessment and verification - Article 14 of the Convention

Each Contracting Party shall take appropriate steps to ensure that:

- (i) comprehensive and systematic safety assessments are carried out before the construction and commissioning of a nuclear installation throughout its life. Such assessments shall be well documented, subsequently updated in the light of operating experience and significant new safety information, and reviewed under the authority of the regulatory body;*
- (ii) verification by analysis, surveillance, testing and inspection is carried out to ensure that the physical state and the operation of a nuclear installation continue to be in accordance with its design, applicable national safety requirements, and operational limits and conditions.*

9.1 Description of the current situation

9.1.1 Licensing process and associated analyses during the project's individual stages (siting, design, construction, operation)

The licensing process legislative framework is defined by Act No. 183/2006 Coll., on town and country planning and building regulations (the Building Act), the Atomic Act and their implementing decrees.

In the case of a nuclear installation construction, the Civil Construction Act established three-stage procedure comprising a site decision (siting) – within competence of the respective local department of planning and building control (unless the regional office or the Ministry for Regional Development reserves this right pursuant to Section 17 paragraph 2 and 3).

The construction permit and operating license (permanent operation) – is issued by the department of planning and building control of the Ministry of Industry and Trade. Their resolutions are conditional upon positions issued by specialized regulatory bodies, including SÚJB. The department of planning and building control of the Ministry of Industry and Trade can issue the operating license only with the approval of the municipal department of planning and building control competent to issue the site decision, which verifies observance of its conditions; the approval is not an administrative action. If neither site decision nor site approval is issued, the opinion of the municipal department of planning and building control on compliance of designed site with projects of regional planning shall be sufficient. For more information see chapter 2.1.2.

The Atomic Act establishes the way of utilization of nuclear energy and ionizing radiation, as well as conditions for the performance of activities related to the utilization of nuclear energy and radiation practices. A precondition for the performance of such activities is a SÚJB license to be issued in an administrative procedure, which is independent of the above-described procedure required under the Civil Construction Act. The Atomic Act explicitly forbids launching siting, construction, operation and other activities at nuclear installations, requiring the SÚJB license, before the respective SÚJB license becomes legally effective. For more details see chapter 3.1.2.

That means that the approval procedure, besides the three-stage process mentioned above, also includes a number of other partial licenses issued by the SÚJB in accordance with the Atomic Act during different stages of the service life of a nuclear installation.

According to the provisions of Section 17 of the Atomic Act, a licensee shall verify nuclear safety during all stages of the installation's service life (in the scope appropriate for the particular licenses), assess it in a systematic and comprehensive manner from the aspect of the current level of science and technology, and ensure that results of such assessments are translated into practical measures. The verification/assessment shall be documented. The content of the documentation is specified in the Appendix to the Atomic Act. Safety assessment is, in compliance with the Atomic Act, reviewed by the SÚJB, both analytically and within its inspection activities. Details concerning the safety related documentation preceding construction of a nuclear installation, preceding its commissioning and during its operation, are described in Chapters 17, 18 and 19 of the Article.

The implementing decrees complement the Atomic Act to establish basic criteria for nuclear safety assessment of a nuclear installation during different stages of its service life.

The following are particularly concerned:

- **SÚJB Decree No. 215/1997 Coll.**, on criteria for siting nuclear installations and very significant ionizing radiation sources,
- **SÚJB Decree No. 195/1999 Coll.**, on basic design criteria for nuclear installations with respect to nuclear safety, radiation protection and emergency preparedness,
- **SÚJB Decree No. 106/1998 Coll.**, on nuclear safety and radiation protection assurance during commissioning and operation of nuclear facilities, which defines and establishes particularly the following:
 - individual stages of commissioning,
 - requirements for the content of the commissioning programs,
 - requirements for the contents of Limits and Conditions for safe operation.
- **SÚJB Decree No. 214/1997 Coll.**, on quality assurance in activities related to the utilization of nuclear energy and in radiation practices, establishing criteria for the classification and categorization of specified installations into safety classes.
- **SÚJB Decree No. 309/2005 Coll.**, on assurance of technical safety of selected equipment

This decree defines the following:

- Method of determination of selected equipment specifically designed for nuclear installation,
- Technical requirements for assurance of technical safety of selected equipment in production and in operation,
- Procedures for consideration of the compliance of selected equipment specifically designed for nuclear installations with technical requirements,
- Method of assurance of technical safety of selected equipment in operation.

As described below, practical application of the requirement to perform systematic and comprehensive assessment of a nuclear installation to check on its continual compliance with its design, applicable safety requirements in the valid national legislation and with Limits and Conditions includes in particular:

- systematic monitoring of nuclear and technical safety (supervision, inspections, tests),

- deterministic evaluation of nuclear safety (Pre-Operational (Final) Safety Report),
- probabilistic safety assessment (so called "living" Probabilistic Safety Assessment Study and its application-risk monitor).

9.1.2 Continual monitoring and periodic assessment of nuclear and technical safety at nuclear installations

Continuous monitoring of the Dukovany NPP and Temelín NPP units' nuclear safety performed by the operator focuses in particular the observation of the Limits and Conditions for safe operation.

This activity is performed both by personnel of the departments responsible for such activities and by specialists of the nuclear safety department in both NPPs. Personnel of the nuclear safety department is responsible for independent verification of the fulfillment of test completion criteria during operation and after maintenance, before equipment after maintenance is ready for operation.

Independent inspections of compliance with additional requirements are performed during outages, dealing with the procedures of works and manipulations on primary circuit technological equipment. The inspections are also performed by personnel of the nuclear safety departments of both NPPs as well as by the managers of other departments whose personnel or, if applicable, contractors, carry out work during the outages.

The information on nuclear and technical safety assurance is presented both in textual and graphic forms. The latter form uses indices containing information about safety systems reliability, conditions of certain equipment in general, environmental impact of NPPs operation and about compliance with the established principles for the given area (fire protection, industrial safety).

The Safety Monitor, version 3.5a, is used to monitor the operational risk level of all units of ČEZ NPPs depending on current equipment configuration. This tool is used at Temelín and Dukovany NPP, and point-in-time risk may be evaluated or pre-calculated by using this tool depending on currently valid or intended NPP technology in given instant of time or during given period of time.

This tool is also used to evaluate the time schedules of all outages for risk level optimization at least two months prior to implemented outage, and to evaluate real or intended changes in time schedule during outage. Original and actual course of the risk is analyzed after outage completion in order to optimize maintenance activities in terms of unit configuration during outage.

Inspections in the area beyond design basis accidents were performed in 2005 and 2006 at Temelín NPP as well as at Dukovany NPP. Such inspections focused on quality and state of the implementation of the control documentation for accident management.

Emergency Operating Procedures (EOPs) and Severe Accident Management Guidelines (SAMGs) were developed and implemented at both NPPs within the accident management program.

EOPs are symptom-based procedures followed by the operating personnel of the main control room in the case of emergency situation solving up to the onset of core damage. EOPs were developed in 1994-1998, verified and validated by 2000, and implemented in 1999 in Dukovany NPP and in 2000 in the case of Temelín NPP. Last revisions of EOPs were

executed in 2005 at both NPPs – at Dukovany NPP Unit 3 as a consequence of I&C system renovation and at Temelín NPP as a consequence of SAMGs implementation.

The Severe Accident Management Guidelines are symptom-based structured guidelines for selection of appropriate strategy for management of accident with fuel meltdown on the basis of current state of the unit. SAMGs as well as EOPs were developed both for Temelín NPP and for Dukovany NPP by NPP personnel in cooperation with the Westinghouse Energy System Europe company on the basis of the so-called generic guidelines for severe accident management. SAMGs were completed at both power plants and issued in 2004 as a set of operating procedures. Updated versions of SAMGs were issued in 2006 for Dukovany NPP Unit 3 with respect to I&C system renovation. In case of both power plants, SAMGs are validated by means of selected validation analysis demonstrating correct selection of strategies and assisting in optimization of some of their aspects.

Progressive improvement of units is under way at both NPPs in respect of severe accidents. The hydrogen combustion program for the case of severe accidents is under way within the MPO (Ministry of Industry and Trade) project common for both NPPs.

The personnel of both NPPs participating in accident management are regularly trained in the use of EOPs and SAMGs. TPS members were trained in the use of SAMGs in March 2007. This training was conducted by Westinghouse company personnel.

The information describing the level of nuclear and technical safety, radiation protection, fire protection and industrial safety is evaluated periodically (weekly reports on the nuclear safety status and monthly and annual reports on the status of safety in the Dukovany NPP and Temelin NPP) and discussed on the individual control levels within ČEZ, a. s. The unavailability of the individual components with impact on nuclear safety is monitored monthly. Results of this monitoring are submitted in the form of operational indicators into the power plants information system network.

Impact of individual component unavailability on nuclear safety is assessed using the immediate value of the Core Damage Frequency as well as a cumulative risk value, which is a product of the Core Damage Frequency and the duration of the component unavailability.

Deterministic nuclear safety assessment (the Initial Safety Report)

The results of nuclear safety assessments at individual units are in compliance with the original and current legislation documented in the safety reports.

As a result of changes and modernization at the Dukovany NPP units, validity of the original Pre-operational (Final) Safety Report of the Dukovany NPP, a document supporting the issuance of the license for permanent operation, has been limited. In 1991, the state regulatory body in its resolution No. 154 established conditions to be met by the operator of Dukovany NPP in order to obtain a license to continue operation of Unit 1, i.e. after 10 years of operation. One of the conditions was to submit an updated Safety Report, at least six months before applying for a license to continue the operation, which shall present the status of nuclear safety assurance at Dukovany NPP units using the current level of science, technology and operational experience.

The safety evaluation in the mentioned updated safety report (Pre-operation (Final) Safety Report, Revision 1) includes a systematic and deterministic analysis of potential failures of structures, systems and components and identifies consequences of such failures. The results have been processed to the level of detail necessary for independent assessment of the

contents, depth and conclusions of the deterministic analysis. The Safety Report submitted to the SÚJB contains a description of the plant enabling independent assessment of its safety features. It also contains information on the site characteristics the design must comply with, including detailed information on main characteristics of the systems, especially those used for reactor control, shutdown, fuel cooling, retention of radioactive substances and information on service life and ageing management assessment of the safety-important components.

In the following years, the Pre-operational (Final) Safety Reports were prepared also for the remaining units of the nuclear power plant.

The Pre-operational (Final) Safety Report is continuously updated (changes in the Pre-operational Safety Report for previous year are presented to SÚJB towards the end of the first quarter). After ten years, an overall revision of the Safety Report is regularly prepared. A precondition for the SÚJB decision for grant of ten-year license allowing operating the Dukovany NPP units after 2005 was the revision of the Pre-operational (Final) Safety Report according to the request of the accepted US standard RG 1.70.

The Periodic Safety Review (the so-called PSR) process was also applied for the Dukovany NPP after 20 years of operation in accordance with new requirements of the IAEA NS-G-2.10 in 2005 and 2006. Preparation of final reports from all fourteen evaluated areas is under way in 2007 (Power Plant Design, Actual Status of Systems, Constructions and Components (SSC), Equipment Qualification, Ageing, Deterministic Safety Analyses, Probabilistic Safety Analyses, Risk Analyses, Operational Safety, Utilization of Operational Experience from Other Power Plants and Research Results, Organization and Administration, Procedures and Regulations, Human Factors, Emergency Planning, Environmental Radiological Impact). A part of the final reports includes lists of findings and their safety assessment, lists of remedial measures and the date of their implementation.

Among others, PSR results provide documentation for preparation of the operating licenses renewal for the Dukovany NPP units after 2015.

The Pre-operational (Final) Safety Report was the basic document of the licensing process during the Temelín NPP commissioning. Each change performed during the commissioning had to be carefully assessed by the operator to prove the compliance with original safety criteria of the Pre-operational (Final) Safety Report. The commissioning process itself was managed to avoid deviation from the conditions and prerequisites verified by safety analyses.

The Pre-operational (Final) Safety Report, common for both Temelín NPP units, was updated with respect to performed changes during commissioning and trial operation. The Pre-operational (Final) Safety Report was prepared in accordance with the internationally accepted US standard RG 1.70. Pre-operational (Final) Safety Report is updated on a regular basis.

Modifications affecting safety and altering the employed Pre-operational (Final) Safety Report prerequisites shall be approved by the SÚJB before their implementation. This procedure was approved for both NPP's by the common agreement between the SÚJB and ČEZ, a. s. Responsibilities of the individual departments of the plant in assessment of the modification impacts on its own processes are specified in the relevant control documentation.

Probabilistic safety assessment of the Dukovany NPP

The first Probabilistic Safety Assessment study (PSA) level 1 of the Dukovany NPP was completed in 1993. The analysis for limited number of internal initiating events and reactor

operation at the nominal power was developed.

Gradual development of the level 1 PSA model was performed; the study was extended to include other initiating events, such as internal fires, floods, consequences of a high-energy pipeline break (HEPB), heavy load drops, etc. Modifications implemented at the nuclear power plant, which included the design changes, equipment replacement and alterations in the operating procedures, have been gradually incorporated into the model. Furthermore, redeveloped analyses (thermal hydraulic, PTS, etc.) have been included and human factor impact has been modeled in more detail. Similarly, low-power modes and refueling outage have been included.

The first results of the level 2 PSA study establishing frequency of the radioactivity release into the environment during severe accidents were handed over to the state regulatory body in April 1998. In 2002, this analysis was updated and new input data was included on the basis of the actual results of the level 1 PSA model and has been thus incorporated into the Living PSA program. Last update of the level 2 PSA study was executed in 2006.

The Shutdown PSA (SPSA), i.e. the PSA for reactor low-power states and for outage, was developed in 1999. The SPSA results showed that the total core damage contribution during outages is comparable to the contribution during operation at full power. Based on the Shutdown PSA results, new and more detailed emergency guidelines were developed. Some modifications in scheduled maintenance management were also performed.

Further to results of the level 1 and level 2 Living PSA study for the Dukovany NPP the effort concentrated on a reduction of impact of the most significant accident sequences. Further changes in the design were made, some equipment was replaced and new emergency procedures were developed. All the planned modifications of the power plant units relating to nuclear safety were evaluated, based on the results of the level 1 Living PSA study, and prioritized in terms of reduction of risk. The results of the level 1 Living PSA study have also been used to support the development of new procedures dealing with emergency and abnormal conditions (level 1 Living PSA) and procedure dealing with beyond the design basis accidents (level 2 Living PSA). New symptom-based procedures have been then incorporated into the PSA model (in 1998 for nominal unit power and in 2002 for shutdown conditions).

With respect to some differences between the individual units of Dukovany NPP, the PSA model for Unit 1 was modified for other NPP units in order to show their actual state; therefore, the PSA models for Units 1, 2, 3 and 4 are currently available.

The I&C system is replaced at Dukovany NPP in stages and this fact was also recorded in the PSA model (in 2005, this modification was included in the PSA model of Unit 3, where the I&C system was already replaced).

The so-called Living PSA study for the Dukovany NPP is a permanent program and, as the previous text show, the work covers the following two main areas:

- updating of the study, i.e. modeling of the implemented modifications, updating of specific reliability data for the units and incorporation of more accurate analyses into the model, etc.,
- Extending of the study scope.

External initiation events such as air crashes, earthquakes or adverse weather conditions have not been incorporated into the PSA study yet.

The PSA study is also utilized in some other applications (in addition to those mentioned

above) such as adjustment of testing intervals for safety-important equipment, IAEA Safety Issues probabilistic assessment, adequacy assessment of existing Limits and Conditions (AOT), assessment of selected operational events, risk-informed in-service inspections (RI-ISI) are on the level of pilot project.

The PSA study for Dukovany NPP is developed in compliance with international standards (IAEA publication, ASME-2 standard, NUREG publication).

The level 1 PSA study for full power unit operation was the subject of the IAEA IPERS mission in 1998. Furthermore, an independent assessment of the PSA study (including study for shutdown conditions and level 2 PSA study) initiated by SÚJB was carried out by Austrian company ENCONET Consulting in 2005.

The PSA study has been currently incorporated into the Living PSA program and consists of level 1 PSA and related level 2 PSA. Its conclusions are included in the Living PSA Summary Report for the respective year. The Summary Report presents detailed results for Unit 1 provided that different values for other units are always available, if required.

The level 1 PSA study establishes the resulting Core Damage Frequency (CDF) for all unit operation modes for Dukovany NPP as well as total Fuel Damage Frequency (FDF) representing the risk level of unit operation with fuel in core as well as in Spent Fuel Pool. Current results of the level 2 Living PSA study expressed by means of six classes of activity leakage from containment are also available; we extract LERF thereof. The following tables show comparison of the main results of the level 1 and 2 PSA study for individual units of Dukovany NPP (towards the end of 2006).

Overview of CDF, FDF and LERF for individual units of Dukovany NPP

	CDF [year ⁻¹]	FDF [year ⁻¹]	LERF [year ⁻¹]
Unit 1	4.32 x 10⁻⁵	5.48 x 10⁻⁵	1.6 x 10⁻⁶
Unit 3	4.06 x 10⁻⁵	5.22 x 10⁻⁵	1.4 x 10⁻⁶
Even, i.e. Unit 2 and 4	4.32 x 10⁻⁵	5.48 x 10⁻⁵	1.6 x 10⁻⁶

Overview of CDF, FDF and LERF of Unit 1 for power and shutdown operational modes

Unit 1	CDF [year ⁻¹]	FDF [year ⁻¹]	LERF [year ⁻¹]
2 - 100 % N_{nom}	3.34 x 10⁻⁵	1.40 x 10⁻⁵	1.6 x 10⁻⁶
N < 2 % N_{nom}	9.76 x 10⁻⁶	4.08 x 10⁻⁵	3.6 x 10⁻⁸
Total:	4.32 x 10⁻⁵	5.48 x 10⁻⁵	1.6 x 10⁻⁶

Probabilistic safety assessment of the Temelín NPP

The probabilistic assessment of the Temelín NPP Unit 1 was developed in 1993 – 1996.

The focus of the PSA project of the Temelín NPP was on severe accident risks, to understand the most probable accident sequences that may occur at the plant, including their importance, to acquire quantitative understanding of the total probability of Core Damage Frequency and frequency of release of radioactive substances and to establish the main contributors to such releases. The PSA project of the Temelín NPP included evaluation of level 1 PSA both at power operation and at low-power status and during outages, and the evaluation of risk, fires, floods, seismic events and other external events. The project also included evaluation of the level 2 PSA, including source terms establishing. As to events, only the potential risks of sabotage and war were not assessed.

Since the beginning, PSA analyses have been drawn up as "Living", including close involvement and development of the individual analyses by the NPP personnel to maintain result models in an actual status for risk-informed applications everyday use either by the PSA specialists or by the NPP operating personnel. One of the above-mentioned applications was also the possibility of risk on-line monitoring of both Temelín NPP units operation. Upon these grounds, the work scope was extended in 1996-1999 and the PSA basic models (for the all operational states and levels 1 and 2) were converted to develop a localized version of the Safety Monitor 2.0 software from the Scientech Company. The main purpose of this software and its related probabilistic models is to analyze the impact of both actual and planned configurations of the NPP, including maintenance activities and equipment tests for immediate operational risk level in all operating modes without the necessity to have any knowledge from the PSA field. Validity of the license for this software was subsequently then purchased for the Dukovany NPP.

In 2003 updating of the PSA analyses of the Temelín NPP was completed, based on current status of the power plant during its commissioning. The analyses updated in 2001-2003 represent the most recent knowledge on the plant's response to emergency situations, current design and operational condition after the implementation of many safety improvements. This enables us to assess the impact of safety related measures at the Temelín NPP, using the Core Damage Frequency (CDF) and Large Early Release Frequency (LERF) and thus acquire a more realistic estimate of the current safety level in the commissioning and further operational stages.

The main results of the updated PSA models of Temelín NPP for analyzed list of initiating events and the Temelín NPP status at the beginning of 2007 represent Core Damage Frequency estimation of the Temelín NPP:

- CDF = $1.49 \cdot 10^{-5}$ /year for power operation at power
- CDF = $9.28 \cdot 10^{-6}$ /year (outage) for all operating conditions of the outage
- CDF = $7.42 \cdot 10^{-6}$ /year for internal fires
- CDF = $1.35 \cdot 10^{-6}$ /year for internal floods
- CDF = below $1.00 \cdot 10^{-8}$ for seismic events
- CDF = below $1.00 \cdot 10^{-7}$ for other external events
- Total CDF = $3.32 \cdot 10^{-5}$ /year for all operating modes and initiating events
- Total LERF = $4.04 \cdot 10^{-6}$ /year (without application of the SAMGs)

At the same time, a new conversion of updated PSA models to the Safety Monitor software environment version 3.5a was performed, including localization. The software operation, including models, is currently tested in the Temelín NPP network environment and is used especially for optimization of maintenance activities during operation as well as during outages, for assessment of the overall risk profile and for support of applications for the evaluation of allowed outage time (AOT).

Real annual cumulative value of CDF, as a result of Temelín NPP operational configuration risk monitoring, amounts to $9.67 \cdot 10^{-6}$ for Unit 1 to $9.4 \cdot 10^{-6}$ for Unit 2 of Temelín NPP as compared with average value of calculated CDF ($1.49 \cdot 10^{-5}$).

The PSA is gradually utilized in a number of other applications (in addition to those mentioned above) such as:

- Equipment modification assessment,

- Justification assessment of emergency planning zone range,
- IAEA Safety Issues probabilistic assessment,
- Adequacy assessment of existing Limits and Conditions and proposal of changes in Limits and Conditions (AOT),
- Operational event assessment,
- Assistance in development of SAMGs (Severe Accident Management Guidelines) and measures of power plant improvement in respect of severe accidents,
- Risk-informed in-service inspections (RI-ISI) – NT SHCHZ, steam lines.

The PSA study for Temelín NPP is developed in compliance with international standards (IAEA publication, ASME-2 standard, NUREG publication).

The PSA study for Temelín NPP was the subject of the IAEA IPERS mission in 1995 (level 1 PSA, internal initiation events) and in 1996 (fires, floods, external events and level 2 PSA). Another IPSART mission took place in 2003 after update of this study. Similarly, an independent assessment of the PSA study in question initiated by SÚJB was carried out by Austrian company ENCONET Consulting in 2005.

9.1.3 Preventive maintenance, in-service inspections of main components, evaluation of ageing

The Dukovany and Temelín nuclear power plants have implemented the following three basic programs with the objective to monitor and to maintain the level of nuclear safety:

- preventive maintenance program,
- in-service inspections program,
- program monitoring ageing of the main components.

Preventive maintenance program

Maintenance is carried out in agreement with the established maintenance program, including the preventive maintenance program, for individual equipment. The methods and scope of maintenance depend on the level of safety and reliability required for the equipment.

The basic maintenance methods applied include:

- preventive maintenance, which is further divided into periodic preventive maintenance and predictive maintenance,
- corrective (ad-hoc) maintenance.

The preventive maintenance is carried out in the prescribed cycles, i.e. regular time intervals defined by real time, number of hours in operation and based on the actual condition of the equipment as identified by audits, inspections and diagnostic measurements. The scope depends on the maintenance type, i.e. a routine repair, medium-sized repair or major overhaul. Results of the inspections, monitoring, nuclear safety and reliability assessments as well as results of the operational diagnostics are employed to evaluate and to optimize the maintenance program for particular equipment.

The maintenance scope and funding are planned in a range of ways, from long-term (5-years) maintenance plans up to daily maintenance plans. A special information system is applied for the purpose of the actual management of maintenance.

Preventive maintenance (as well as repairs) is often contracted to qualified companies –

mostly manufacturers of the equipment (Vítkovice Ostrava, Škoda Plzeň, Sigma) - and to the companies established through transformation of the plant's own maintenance section. All those activities are carried out in accordance with the established procedures and under supervision.

In-service inspections program

In-service inspections are carried out in accordance with an inspection plan approved by the SÚJB for safety related components as selected by the design of NPP. The selection has been also approved by the SÚJB. The inspection programs for individual components were proposed by the equipment manufacturers and are included into the so-called "individual" quality assurance programs for each component.

The following methods are used for the inspection purposes: visual inspection, fluorescent penetrant inspection, magnetic powder, eddy currents, ultrasound transmission, ultrasonic thickness measurement, dimension measurement, tightness and pressure tests, diagnostic measurements. The range and number of these methods depend on the particular component's importance. In accordance with the ENIQ methodology NDT methods are qualified on the safety-important components. Inspections performed by automated methods are, as a rule, contracted from external suppliers, usually manufactures of the monitored equipment or from specialized companies, which are also qualified accordingly.

Components life monitoring program

A component life monitoring program on both NPPs focuses particularly on the main plant components important for nuclear safety.

In respect to the primary circuit equipment residual service life of the reactor pressure vessel is monitored including its internals, of steam generator, main circulation pumps and pressurizers; the residual service life is also monitored for the main circulation pipeline. Input data into the service life monitoring program are the measured process parameters (especially temperature, pressure and dose load), as well as information obtained from non-destructive in-service inspections, chemical data to identify a particular corrosion environment, as well as material and physical properties.

For the secondary circuit a similar program focuses on the piping systems, where the erosive corrosion is the most significant damaging phenomenon.

The Ageing Management Program or more precisely the Plant Life Management (PLIM) has been used at the Dukovany NPP as well as at Temelín NPP since the beginning of their operation. In view of the fact that Dukovany NPP has already exceeded half of its life originally set by the design and further that ČEZ, a. s. declared a strategic objective for its NPPs to stretch out the life span by 10 years as a minimum, the work was commenced in order to develop a Long Term Operation program in accordance with world wide experience. Therefore, ČEZ, a. s. took part in the IAEA program called the Safety Aspects of Long Term Operation (SALTO).

Degradation mechanisms are identified in the life management process a mathematical description of the material damage process is created and subsequently the monitoring program for the evaluation of material damage trends and thus for the determination of the residual life is established.

In the Dukovany NPP, diagnostic software DIALIFE has been created for the machine technologies, performing the calculation of the equipments residual life using verified

calculation programs based on information from the technological information systems of the production units, diagnostics, chemistry, special measurements, SCORPIO system, non-destructive testing results, and material properties database. In this way life monitoring of the following equipment is performed:

- steam generator,
- pressurizer,
- main circulation pump,
- main (coolant) circulation pipeline,
- evaluation of fatigue damage of the reactor pressure vessel.

For the monitoring in DIALIFE, the pipes of safety class 1 and 2, including the compensation pipe, are prepared.

Great attention is paid to the radiation embrittlement of the reactor pressure vessel. The program "Complementary surveillance program project" applied in Dukovany NPP removes, among others, the inaccuracies of the descending reduction and interpretation of data about neutron fluence, and enables to monitor the lifetime during the whole reactor pressure vessel life in accordance with the legislation and international standards.

Erosion/corrosion of piping systems made of carbon steel is monitored in the Dukovany NPP by the CHECKWORKS program on following systems:

- feed water to steam generator,
- live steam,
- residual heat removal,
- feeding tank emptying into condenser,
- condensate to feeding tank,
- pipes 6, 7 and 8 of the turboset extraction,
- heating steam condensate from the high-pressure re-heater,
- condensate pumps discharge pipe to low-pressure re-heaters 1, 2, 3, 4, 5.

Similarly, in the Temelín NPP, diagnostic software DIALIFE is created for the machine technologies, performing the calculation of the equipments residual life using verified calculation programs based on information from the technological information systems (production units, diagnostics, chemistry, special measurements, non-destructive testing results, and material properties database). The Langer, Mason-Cofin and Woehler design life curves may be used in the program. In this way life monitoring for the low cycle fatigue of the following equipment is performed:

- steam generator,
- pressurizer,
- main circulation pump,
- main (coolant) circulation pipeline and energy pipeline connected thereto leading to the first stop valve, including the pipeline between pressurizer and loops,
- evaluation of fatigue damage of the reactor pressure vessel,
- bubbler tank and its feed piping,
- steam outlet pipeline from steam generator,
- reactor residual heat removal exchanger,
- diesel generators.

The monitoring applies to approximately 2000 points (reactor 1160, pipeline 638, MCP 104).

The DIALIFE includes also mathematical description of the material damage process caused by stress corrosion.

Great attention is paid to the radiation embrittlement of the reactor pressure vessel. Full-valued surveillance program is implemented for the reactor pressure vessel materials, including cladding, in accordance with the legislation and international standards.

The inner reactor was verified using the accelerated in-pile experiments.

In addition, the online system is installed within the primary circuit diagnostic system to monitor and evaluate the MAFES temperature and pressure cycles. The evaluation is performed in 9 sections in the vicinity of potentially critical areas of weld deposits on the primary pipeline.

Erosion/corrosion of piping systems made of carbon steel is monitored in the Temelín NPP by the CHECKWORKS program on following systems:

- feed water to steam generator,
- live steam in the room 820 (intermediate turbine hall),
- pipes of the turboset extraction,
- regeneration condensate pipe.

9.1.4 Regulatory practice

The SÚJB authority is given by the Atomic Act

Nuclear and technical safety is evaluated and inspected through:

- the inspection activities aimed at observation of the Atomic Act and its implementing regulations,
- the so-called "licensing" procedures (to issue licenses for particular practices),
- the approvals of documentation as defined by the Atomic Act.

The verification of a nuclear and technical safety status by SÚJB is based particularly on its inspection activities. Section 39 of the Atomic Act establishes authority for SÚJB inspectors to carry out inspection activities. Section 40 establishes authority of the inspectors to require that remedial measures are adopted within established deadlines, impose corrective measures, inspections, tests and reviews, including the right to propose fines. Moreover, in agreement with Section 40, the SÚJB is authorized, in the event of hazard arising from delay or occurrence of undesirable situation with impact on nuclear safety, to issue a provisional measure imposing the obligation to reduce the power output or even to suspend operation of the nuclear installation. For details – see chapter 3.1.2.

Essentially, there are three different forms of inspection activities performed by the SÚJB:

- routine inspections,
- planned specialized inspections,
- inspections responding to a particular situation (the so-called "ad-hoc" inspections).

The routine inspections are planned to cover all regular important activities performed by the licensee, especially in respect to compliance with the Limits and Conditions for safe operation. This plan is developed based on the plans for operation, requirements of Limits and Conditions and requirements in the operating procedures; the inspections are performed on

daily, weekly and quarterly basis. Results of the routine inspections are usually evaluated once a month. The evaluation activity is documented in monthly reports and discussed with the licensee. The routine inspections are mostly performed by resident inspectors located at the individual nuclear installations and dedicated particularly for such activities.

In case of the planned specialized inspections a regular semi-annual plan is developed based on:

- evaluated results of the inspections performed during a previous period,
- plan of the nuclear installation operation,
- evaluation and conclusions of routine inspections,
- conclusions of the SÚJB assessment effort,
- independent analyses, findings and safety analyses.

The inspections are usually carried out by a team of inspectors, made up of resident inspectors and inspectors from the Central Office. The so-called "ad-hoc" inspections are performed to examine events and failures with impact on nuclear safety, as well as to clarify serious findings from the routine or planned inspections.

The SÚJB assesses the level of nuclear safety also in the course of the so-called "licensing" procedure to issue licenses for activities identified in the Atomic Act. Moreover, the SÚJB assesses the level of nuclear safety assurance within the following activities:

- assessment of the periodically submitted Pre-operational (Final) Safety Report (requirements for its submittal are specified in the respective SÚJB resolution),
- evaluation of the in-service inspections program,
- evaluation of the program for the enhancement of nuclear installations safety,
- evaluation of feedback from the operational experience and implementation of the latest scientific knowledge and technology.

In agreement with the Atomic Act, all results obtained by the SÚJB in the area of nuclear safety verification and assessment are regularly submitted to the government on annual basis. The results are also made available to the general public.

9.2 Statement on the implementation of the obligations concerning Article 14 of the Convention

In agreement with the requirements of Article 14 of the Convention, the Czech licensee performs comprehensive and systematic safety evaluation before a nuclear installation construction, commissioning and throughout its whole service life. The evaluation is documented and regularly updated at prescribed intervals to reflect operational experience and significant new scientific and technological information relating to nuclear safety and, in compliance with the Act, assessed by the responsible regulatory body. The requirements of Article 14 of the Convention are thus fulfilled.

10. Radiation Protection – Article 15 of the Convention

Each Contracting Party shall take the appropriate steps to ensure that in all operational states the radiation exposure to the workers and the public caused by a nuclear installation shall be kept as low as reasonably achievable and that no individual shall be exposed to radiation doses which exceed prescribed national dose limits.

10.1 Description of the current situation

10.1.1 Summary of legislation relating to radiation protection

Radiation protection in Czech nuclear installations is regulated by the Atomic Act and its implementing SÚJB Decree No. 307/2002 Coll., on radiation protection.

The legislation in the radiation protection area is consistently based on internationally recognized radiation protection principles which observe recommendations of renowned international non-governmental expert organizations and especially recommendations issued by the International Commission on Radiological Protection (ICRP) No. 60 of 1990, as well as on related international fundamental standards for radiation protection approved by intergovernmental organizations, including the International Atomic Energy Agency.

In 2002, the national legislation was fully harmonized with the corresponding directives of the European Union, particularly with the Council Directive 96/29/Euratom of May 13, 1996. Other amendments of 2005 and 2006 specified the legislation by practical experience. The Atomic Act shall lay down the system of the protection of individuals and the environment against the adverse effects of ionizing radiation. General obligations associated with the utilization of nuclear energy and ionizing radiation together with the conditions of the performance of activities associated with the utilization of nuclear energy radiation practices are established in Section 4 of the Act. They include particularly the following general obligations:

- *"Anybody who utilizes nuclear energy or performs radiation practices or interventions to reduce exposure due to radiation accidents, shall justify such activities by their benefits, which shall offset any possible existing or potential risks (the so-called justification principle)",*
- *"Anybody who utilizes nuclear energy or performs radiation practices, prepares or performs interventions to reduce accidental exposures, shall maintain such a level of radiation protection so that risks to life and health of people and to the environment are as low as reasonably achievable, economic and social factors being taken into account " (the so-called optimization principle, ALARA principle)",*
- *"Anybody who performs selected radiation practices, including utilization of nuclear energy shall make sure that the total sum of exposure caused by a potential combination of exposures from radiation practices does not exceed the exposure limits established by SÚJB determined. (the so-called dose limitation principle)",*
- *"The exposure of any individual involved in actions responding to a radiation accident shall not exceed the tenfold of the limit established for the exposed workers, unless human lives are at risk or prevention of further development of the radiation accident with potential extensive social and economic consequences",*

- *"Intervention measures to avert or reduce accidental exposure shall be adopted whenever the expected exposure approaches to the levels where their health is immediately impaired by the exposure or whenever such measures are expected to bring more benefits than drawbacks".*

The Atomic Act establishes the obligation to obtain a license from SÚJB for practices listed in Section 9 (siting, construction, individual stages of commissioning, etc.). For more details see chapter 3.1.2. The same applies for the release of radionuclides into the environment and for radioactive waste management. A number of additional obligations for the licensee are established in Sections 17 – 19 of the Atomic Act. In respect to the radiation protection at nuclear installations the obligations include in particular:

- to assure radiation protection in the scope required by the particular licenses and to assure systematic supervisions of compliance with radiation protection requirements,
- to comply with the conditions specified in the license issued by SÚJB, to proceed in accordance with approved documentation and to promptly investigate any violation of such conditions or procedures, and to adopt corrective measures to prevent the situation occurring again, including the obligation to promptly report all cases where any exposure limit has been exceeded to the State Office for Nuclear Safety,
- to comply with the technical and organizational conditions for the safe operation of nuclear installations as laid down in the implementing decrees,
- to participate in the functioning of the National Radiation Monitoring Network to the extent established in a government order,
- to promptly report to the State Office for Nuclear Safety any change or event affecting nuclear safety, as well as any change in circumstances decisive for issuance of the license,
- to provide the general public with information on nuclear safety and radiation protection assurance,
- to monitor, measure, evaluate, verify and record all values, parameters and facts important from the radiation protection point of view, in the scope established in the implementing regulations, including radiation monitoring of individuals, the workplace and its vicinity, to keep and file records on the mentioned facts and to submit the recorded information to the State Office for Nuclear Safety in a manner specified in an implementing regulation,
- to minimize the produced quantity of radioactive wastes and spent nuclear fuel to the necessary level,
- to prepare and hand over to Radioactive Waste Repository Authority (SÚRAO) data on short-term and long-term production of radioactive waste, spent nuclear fuel, and other information necessary to determine the amount and method of payments to the nuclear account,
- to keep records about radioactive wastes by type of waste, in such a manner that all characteristics affecting its safe management are apparent,
- to provide for regular medical checkups of personnel who handle ionizing radiation sources,
- to provide a system of training, verification of competence and special professional competence of the personnel in accordance with the importance of the work they perform.

The Atomic Act also establishes the rights and obligations with respect to radioactive waste management. Depending on a level of contamination the Atomic Act basically distinguishes between three categories of radioactive wastes.

- wastes which satisfy the generic clearance levels stipulated by the SÚJB Decree No. 307/2002 Coll. (Section 57), and which may be discharged into the environment without the permit issued by the SÚJB,
- wastes exceeding these clearance levels, and which may be discharged into the environment following a relevant administrative procedure, based on a permit issued by the SÚJB, and in a manner and under conditions specified therein,
- wastes highly contaminated with radionuclides, requiring a long-term isolation from the environment and disposal in a radioactive waste repository. The disposal of radioactive wastes is entrusted by law to the Radioactive Waste Repositories Agency (SÚRAO).

The basic decree for the implementation of the Atomic Act in the radiation protection area is the SÚJB Decree No. 307/2002 Coll., on the radiation protection. The decree specifies details of the manner and extent of the assurance of the protection of individuals and environment against adverse effects of ionizing radiation during radiation practices as well as during the preparation for and actual performance of actions to reduce the existing exposure; the regulation is thereby used for the implementation of the majority of authorizations established in the Atomic Act in respect to the radiation protection.

Among other things, the SÚJB Decree No. 307/2002 Coll. quantifies, which materials and objects are considered radionuclide sources, i.e. which things and objects are subject to regulation and, on the other hand, which may be excluded from the regulation. The decree establishes the criteria for ionizing radiation sources classification into 5 categories: as insignificant, minor, simple, significant and very significant sources (from Section 4 to Section 10), the criteria for categorization of workplaces, where the radiation activities are performed, into workplaces of categories I. to IV. (from Section 11 to Section 15), and the criteria for categorization of exposed workers into categories A and B (Section 16). The decree also defines the procedures and criteria related to the radiation protection optimization (Section 17) and decree introduces values of dose limits (from Section 18 to Section 23) too.

The SÚJB Decree No. 307/2002 Coll. also governs the details of methods and the scope of radiation protection provision in the course of radiation practices and in the course of actions to reduce exposure from radiation accidents, and it particularly:

- establishes the scope and manner of handling the ionizing sources requiring license, and the requirements for radiation protection provision for the individual types they are handling,
- governs the details of radioactive waste management and the release of radionuclides into the environment,
- establishes technical and organizational conditions of safe operation of ionizing radiation sources and workplaces using such sources, including details about the controlled area definition and the categorization of workplaces with sources of ionizing radiation,
- defines values, parameters and facts necessary from the radiation protection point of view, establishes the scope of their monitoring, measuring, evaluation, verification, recording, registration and method of data transmission to the State Office for Nuclear Safety,

- establishes the guideline levels and details on rules for the adoption of measures to prevent or reduce exposure during a radiation accident.

10.1.2 Implementation of radiation protection requirements

Dose limits

New regulations issued in 2002 made the dose limit values to conform to the Council Directive 96/29/Euratom.

The most frequently used whole body dose limits are now expressed as internationally recommended values, which express the effect of exposure on the whole human organism (the effective dose). The values represent a sum of effective doses from the external exposure and relevant committed effective doses from internal exposure in a specified period. New regulations, unlike the previous ones, establish neither limits for periods shorter than one calendar year nor limits related to periods longer than five consecutive calendar years.

The limits for individual members of a population, i.e. persons usually exposed involuntarily and unconsciously, are lower than the limits for persons who are aware of the possible risks and are exposed voluntarily and intentionally, either while executing their professional duties or while being trained for such a profession.

The effective dose limits for occupational exposure of personnel of categories A and B, i.e. persons exposed to radiation in connection with the performance of radiation practices, are 100 mSv for the period of five consecutive calendar years, providing that in one calendar year the value shall not exceed 50 mSv. In addition, a routine regular monitoring is required of personal doses received by personnel in category A, which also includes all persons working in controlled areas of nuclear installations, while the resulting records shall be kept on file until the individual has or would have attained the age of 75 years, but in any case not less than 30 years from the termination of the work involving exposure to ionizing radiation. To monitor the personnel in categories A and B the SÚJB Decree No. 307/2002 Coll. also establishes derived limits that are easier to monitor and expressed in more immediately measurable units.

The effective dose limit for the individuals between 16 and 18 years of age, who are exposed to radiation consciously and voluntarily in the course of special training for their future profession, and who have been in a demonstrable way instructed about their potential occupational exposure and about the related risks, is 6 mSv in a single calendar year.

The general effective doses limits, i.e. limits related to all other individuals from the population, are 1 mSv for one calendar year or, under conditions laid down in the permit to operate the workplaces of category III. or IV., exceptionally the value of 5 mSv for the period of five consecutive calendar years.

The general limits are related to the average calculated exposure of the most exposed population group, for all expected exposure ways from ionizing radiation sources and all radiation practices, which are to be considered. If no direct data is available for such calculations, the conservative estimates of factors affecting the spreading of radionuclides or the exposure of individuals of the most exposed population group, must be used. To monitor, in an easier way, the adherence to exposure limits of individuals in the vicinity of a certain installation, the State Office for Nuclear Safety has the right to establish the dose constraints related to the exposure caused exclusively by this installation and serving as the upper bound to optimize the radiation protection of the nearby population.

Conditions for discharges of radioactive substances

The discharging of liquid and gaseous radioactive substances from nuclear installations into the environment is, in accordance with the Atomic Act (Section 9) subject to the permit issued by SÚJB, and more details, including the criteria necessary for the corresponding permit, are established in Section 56 of the SÚJB Decree No. 307/2002 Coll. In addition, the latter establishes the dose constraint for a total discharge of radioactive substances from a workplace where radiation activities are performed shall be an average effective dose of 250 microsievert (μSv) per calendar year for the appropriate critical group of the public, from which 200 μSv shall be for discharges into the atmosphere and 50 μSv for discharges into watercourses from nuclear installations. Each discharge shall be justified and optimized. Therefore the authorized limits of discharges into the atmosphere as well as into the watercourse are of considerably lower order for individual nuclear power plants.

.A permit to discharge radionuclides into the environment is issued by the SÚJB. However, for discharges into the watercourse a broader authorization is issued by the relevant water management authority, and on which SÚJB issues binding opinion with respect to problems related to the radioactivity of waters.

The authorized limits for effluents expressed in effective doses and committed effective doses of the individual from the reference group of the population (also called “critical group”) in the vicinity of NPP are established for Dukovany and Temelín NPPs.

All real discharges are monitored by an extensive monitoring system operated both by the nuclear installation operators and by the independent measurements carried out directly by the SÚJB or through the State Institute for Radiation Protection. The measurement results provide reliable evidence that the permitted authorized limits are not exceeded and that the maximum effective dose to an individual from a critical group of population due to discharges in the vicinity of the nuclear installations is not higher than tenths to hundreds of nano-Sieverts per year.

Optimization in radiation protection

The technical and organizational requirements, limits and procedures used for the justification of a reasonably achievable level of radiation protection are established in Section 17 of the SÚJB Decree No. 307/2002 Coll. The requirements are assessed within the licensing process and in the course of regular inspections. For nuclear installations this means that:

- the corresponding protective measures as well as collective doses and doses in the relevant critical groups have to be assessed and compared before the commencement of each activity resulting in exposure,
- regular (annual) analysis of doses received during the activity resulting in exposure must be carried out, while considering additional measures available to assure the radiation protection and comparison with similar operated and socially acceptable activities.

The reasonably achievable level of radiation protection can be demonstrated by a procedure, which compares the costs of alternative measures for the enhancement of radiation protection (e.g. introduction of additional barriers) with the financial benefits expected from the correspondingly reduced exposure. The reasonably achievable level of radiation protection shall be considered proven and no additional measures are required if the costs are higher than the benefits.

The SÚJB Decree No. 307/2002 Coll. establishes the amounts of monetary equivalents for the reduction of collective effective doses of exposed personnel or population, scale based on the expected average effective dose and exposure limits. The decree also takes into account the possible need for the adjustment of the financial amounts.

A reasonably achievable level of radiation protection shall be also considered to sufficiently proved if an annual effective dose of the exposed workers arising from a certain radiation activity does not exceed 1 mSv for each exposed worker even for predictable deviations from normal operation, and an annual effective dose to the public does not exceed 50 μ Sv for each individual, and a collective effective dose at a category IV workplace does not exceed 1 Sv. In such cases, it is not necessary to optimize radiation protection.

A dose constraint for a nuclear installation operation shall be a collective effective dose of 4 Sv per year for each gigawatt being installed in the nuclear installation related to the exposure of all exposed workers who undergo personal monitoring in compliance with the monitoring programme.

Radiation monitoring in the vicinity of nuclear installations

An operator of a nuclear installation is legally responsible for the radiation monitoring in the installation vicinity. The monitoring shall be carried out in accordance with the monitoring program approved by the SÚJB. The monitoring program establishes the scope, frequency as well as the methods of measurement and evaluation of results and the corresponding reference levels. The monitoring at nuclear installations is currently performed, as a rule, directly by specialized departments of the operator. The SÚJB inspects the fulfillment of the monitoring program and also performs its own independent measurements.

The dose rates in the vicinity of Dukovany NPP and Temelín NPP are continuously monitored by a teledosimetric system operated by the nuclear power plant. There is at least one point of the national independent early warning network close to each plant (see later). Monitoring of the equivalent dose rates due to external exposure in the vicinity of the nuclear power plants is performed by local networks of thermoluminescent detectors operated by the radiation monitoring laboratory of the respective plant. Independently of these networks, the SÚJB Regional Centers perform their own measurements using the thermoluminescent detectors. Until now, none of these networks has recorded any violation of the investigation levels caused by the operation of the nuclear power plant.

Regular sampling and measurements of radionuclides activity in components of the environment in the vicinity of Dukovany NPP is carried out by the radiation monitoring laboratory and the SÚJB Regional Center in Brno. In the vicinity of Temelín NPP the measurements are performed by the radiation monitoring laboratory and the SÚJB Regional Center in České Budějovice.

Since the nuclear installations are part of the National Radiation Monitoring Network, the regulatory bodies receive regular overviews of the measurement results. Moreover, the operator of the nuclear power plants on its own initiative publishes various information materials for the public. This area is governed by the Government Order No. 11/1999 Coll., on the emergency planning zone (see chapter 2.1.2).

A number of other measurements are performed in the nuclear power plants vicinity with the objective to detect and assess any release of radioactive substances and to provide credible background information necessary to make decisions on the measures to protect the population. The measurements are performed within the National Radiation Monitoring

Network coordinated by the SÚJB. Results of the monitoring are submitted to the Committee for Civil Defense and Emergency Planning and to the public in annual reports on the radiation situation on the Czech Republic's territory, through the relevant Regional Authorities, sanitary stations and libraries.

The function and organization of the Radiation Monitoring Network are governed by the SÚJB Decree No. 319/2002 Coll. The Radiation Monitoring Network operates in two modes: the "regular" mode focuses on monitoring of the current radiation situation and on early detection of a radiation accident, while the so-called "emergency" mode focuses on the assessment of consequences of such an accident. The regular mode is carried out continuously by so called "permanent elements" of the Radiation Monitoring Network. The emergency mode uses also its "emergency elements". The monitoring in normal conditions is carried out by several subsystems using either some selected or all permanent elements of the Radiation Monitoring Network. The subsystems can be divided into the following groups:

- early warning network, composed of 54 continually working measuring points with the automatic data transmission of the measured values to the central database,
- territorial TLD network of 205 measuring points equipped with thermoluminescent dosimeters, of which 21 measuring points in local networks in the vicinity of Dukovany NPP and Temelín NPP,
- local TLD networks with 92 measuring points equipped with thermoluminescent detectors in the vicinity of Dukovany NPP and Temelín NPP,
- territorial network for air contamination measurements which includes 11 air-contamination measuring points, equipped with large-scale sampling equipment for aerosols and fallouts,
- network of 9 laboratories performing the gamma-spectroscopic and radiochemical analyses of the radionuclides content in the environment samples (aerosols, fallouts, food, drinking water, feedstuff, etc.),
- mobile groups and aircraft group equipped with the instrumentation measuring the dose rates in the atmosphere (volume activity) and on the ground (deposition of radionuclides).

Participation in the international exercises has confirmed that the Czech Radiation Monitoring Network is comparable with the European standards in respect to its equipment and density of measuring points.

10.1.3 Supervisory activities

The Atomic Act entrusted the execution of the state supervision of the radiation protection in the Czech Republic to SÚJB (see chapter 3.1.2).

The inspection activities in radiation protection are performed by the SÚJB radiation protection inspectors. At present, there are in total 58 inspectors, located at the Central Office in Prague and at eight Regional Centers all over the country. The inspectors are required to prove their professional competence in the field, to have a university degree in the respective field and at least three years of professional experience. The inspectors are appointed by the SÚJB Chairperson. For more details see chapter 3.

The inspections are carried out by the inspectors of the SÚJB Regional Centers within the territory of the relevant region, or by the Specialized Inspection Groups focused on specific types of ionizing radiation sources and their workplaces, where it is required to achieve a

higher level of the unification of radiation protection practices all over the state (e.g. nuclear medicine workplaces, workplaces with open radionuclide sources of category II and higher, nuclear energy, radio-therapeutic workplaces, etc.). This inspection system is complemented by inspections carried out ad hoc for special inspections, especially at the workplaces of categories III and IV.

The inspections are carried out in accordance with standards governed by the SÚJB internal documentation, which includes the establishment of principles for the preparation of inspections, their performance, evaluation and recording of results to the central database.

The inspections carried out in the field of nuclear power are evaluated in the SÚJB feedback system on a monthly basis with a view to achieving high standard of inspection efficiency. As for the indicators for radiation protection at nuclear installations within the countries associated within the OECD, the Czech Republic reaches first place in the category of light-water and heavy-water reactors (see annual reports of OECD, NEA, ISOE), which shows evidence of efficiency of this method of inspection activity assurance.

10.2 Statement on the implementation of the obligations concerning Article 15 of the Convention

The requirements of Article 15 of the Convention are fulfilled in the Czech Republic, both in respect to legislation and implementation.

11. Emergency preparedness - Article 16 of the Convention

1. *Each Contracting Party shall take the appropriate steps to ensure that there are on-site and off-site emergency plans that are routinely tested for nuclear installations and cover the activities to be carried out in the event of an emergency.*
For any new nuclear installation, such plans shall be prepared and tested before it commences operation above a low power level agreed by the regulatory body.
2. *Each Contracting Party shall take the appropriate steps to ensure that, insofar as they are likely to be affected by a radiological emergency, its own population and the competent authorities of the States in the vicinity of the nuclear installation are provided with the appropriate information for emergency planning and response.*
3. *Contracting Parties which do not have a nuclear installation on their territory, insofar as they are likely to be affected in the event of a radiological emergency at a nuclear installation in the vicinity, shall take the appropriate steps for the preparation and testing of emergency plans for their territory that cover the activities to be carried out in the event of such an emergency.*

11.1 Description of the current situation

11.1.1 Summary of national legislation for on-site and off-site emergency preparedness

The national legislation is in compliance with the IAEA documents such as TECDOC 718, Drawing Up a National Plan of Measures for the Case of Radiation Accidents; TECDOC 953, Method for Creating an Emergency Response Preparedness During Nuclear or Radiation Accidents; TECDOC 955, Basic Evaluation Procedures for Adoption of Protective Measures In the Course of the Reactor Accident.

The legislative framework for the emergency preparedness of nuclear installations and their vicinities is in particular given by the Atomic Act, its implementing decrees and related government ordinances (see Chapter 2.1.2).

The provision of Section 2 of the Atomic Act defines the basic terms – emergency preparedness, radiation incident, radiation accident, radiological emergency, emergency exposure, emergency planning zone, on-site emergency plan (plan developed for the premises of nuclear installation or workplace where the radiation activities are performed) and off-site emergency plan (plan developed for the emergency planning zone).

In accordance with Section 3 of the Atomic Act, within its competence, the SÚJB:

- approves on-site emergency plans and their modifications after discussion on the relations to off-site emergency plans; the approval of on-site emergency plan is one of the conditions for obtaining a permit for the commissioning of the installation and its operation,
- establishes an emergency planning zone, based on the licensee request,
- controls the activity of the National Radiation Monitoring Network and performs the activities of its head office,

- ensures the activities of the Emergency Response Center and international information exchange on the radiation situation,
- ensures, by means of the National Radiation Monitoring Network and based on assessment of the radiation situation, the background information necessary to take decisions aimed at reducing or averting exposure in the case of a radiation accident,
- is obliged to provide the public with adequate information concerning the results of its activities, unless they are subject to state, professional or business secret, and to publish once a year a report on its activities and to submit the report to the Government of the Czech Republic and to the public.

Among other things, Section 4 of the Atomic Act establishes the principles for performance of radiation activities and limiting emergency exposure. The principles for averting or reducing exposure due to radiation accidents and exposure of people who participate in the mitigating interventions are elaborated in the implementing SÚJB Decree No. 307/2002 Coll., on radiation protection.

Within the general obligations, the provision of Section 17 of the Atomic Act establishes the obligation of a licensee to ensure emergency preparedness, including its verification, in the scope appropriate for the particular licenses, and to report to the SÚJB any change important from the emergency preparedness point of view, including changes in any facts relevant for license issuing.

The provision of Section 18 of the Atomic Act establishes, besides other obligations, the obligation of a licensee to:

- monitor, measure, evaluate, verify and record values, parameters and facts important for emergency preparedness, to the extent laid down by implementing regulations,
- keep and archive records of ionizing radiation sources, facilities, materials, activities, quantities, parameters and other facts important from the emergency preparedness point of view, and to submit the recorded data to the SÚJB in the manner laid down in an implementing regulation,
- ensure systematic supervision of observance of emergency preparedness, including its verification.

The provision of Section 19 of the Atomic Act establishes as one of the obligations of the license in the event of radiation incident, to the extent and in the manner determined by the on-site emergency plan approved by the SÚJB, to:

- notify immediately the relevant Regional Authorities, the SÚJB and other relevant bodies specified in the on-site emergency plan, of the occurrence or suspected occurrence of a radiation accident,
- ensure immediately warning the public within the emergency planning zone in case of a radiation accident,
- ensure immediately that the consequences of the radiation incident are dealt with in the premises, where his activities are performed and to take measures to protect employees and other persons from the effects of ionizing radiation,
- ensure the monitoring of exposures of employees and other persons, and prevent any release of radionuclides and ionizing radiation into the environment,
- inform relevant bodies, in particular on monitoring results, on factual and expected development of the situation, on interventions taken to protect employees and the

public, and on measures taken to deal with the radiation accident and also on the factual and expected exposure of people,

- control and regulate exposure of employees and other persons participating in the radiation incident mitigation within the premises where the licensee performs his activities,
- cooperate in dealing with the consequences of the radiation incident which occurred on his premises,
- participate, in case of radiation accident, in the activities of the National Radiation Monitoring Network.

In addition, the same Article also establishes the obligation of the licensee to submit to the appropriate Regional Authority and to the relevant Municipal Offices with extended competence background documents to prepare the off-site emergency plan and to co-operate with the authority in order to ensure emergency preparedness within the emergency planning zone.

The Article also establishes that a governmental order will lay down a financial share of the licensee in covering activities of the National Radiation Monitoring Network in providing the public within the emergency planning zone of relevant installations or workplaces with antidotes, in running a press and information campaign aimed at ensuring that the public is prepared for radiation accidents, in providing a system for the notification of the relevant bodies to the extent and in the manner established in the on-site emergency plan, in providing a warning system to inform the public living in the vicinity of the nuclear installation, as well as the obligation to participate in the removal of the consequences of the radiation accident within the emergency planning zone.

Based on the provision of Section 46 some ministries are obliged to participate in providing for the emergency preparedness, i.e. this Article establishes that: for requirements of the Radiation Monitoring Network on the Czech Republic's territory:

- a) the Ministry of Finance ensures operation of specified parts of monitoring points at border crossings and participates in operation of mobile monitoring groups;
- b) the Ministry of Defence participates in operation of Early Warning Network, monitoring points at roadblocks and border crossings, operation of mobile monitoring groups and aircraft monitoring groups and ensures means of aerial survey;
- c) the Ministry of Interior participates in operation of mobile groups;
- d) the Ministry of Agriculture participates in operation of water contamination monitoring points and foodstuffs contamination monitoring points;
- e) the Ministry of Environment ensures meteorological support and participates in operation of the Early Warning Network, air contamination monitoring points and water contamination monitoring points;

The Ministry of Health creates a system of special medical care provided by selected clinics to persons irradiated during radiation accidents.

Details and requirements for emergency preparedness in the case of extraordinary events (radiation incidents and accidents) are established in the implementing regulations related to the Atomic Act:

- **SÚJB Decree No. 318/2002 Coll.**, on details in emergency preparedness of nuclear installations and workplaces with ionizing radiation sources, and on requirements on

the content of on-site emergency plans and emergency rules, as amended by the SÚJB Decree No. 2/2004 Coll.,

- **SÚJB Decree No. 307/2002 Coll.**, on radiation protection, as amended by the SÚJB Decree No. 499/2005 Coll.,
- **SÚJB Decree No. 319/2002 Coll.**, on function and organization of the National Radiation Monitoring Network, as amended by the SÚJB Decree No. 27/2006 Coll.,
- The **SÚJB Decree No. 318/2002 Coll.**, establishes details of assuring emergency preparedness of nuclear installations, such as:
 - identification of extraordinary event occurrence,
 - assessment of the extraordinary events significance and their classification in three basic degrees,
 - announcing an extraordinary event,
 - activation of intervening persons,
 - management and implementation of the intervention,
 - requirements for the intervention procedures and instructions,
 - requirements for the radiation situation monitoring program,
 - methods to limit exposure of the employees and other persons,
 - medical provision principles,
 - ensuring documenting of the activities during an extraordinary event,
 - submitting information on the occurrence and development of an extraordinary event to the SÚJB,
 - requirements for training of employees and other persons,
 - requirements for the emergency preparedness verification, including emergency exercises and tests of function of technical means, systems and devices necessary for management and implementation of the interventions,
 - requirements for the contents of an on-site emergency plan,
 - requirements for other documentation related to emergency preparedness.

The **SÚJB Decree No. 307/2002 Coll.**, in the provision of Section 92, stipulates general regulations for the preparation and performance of the interventions, and in the provision Section 98 through Section 100 and in the Annex No. 8 establishes details in the manner and scope of radiation protection assurance during interventions to reduce exposure due to radiation accidents. Furthermore, the Decree establishes guidance levels for the early and recovery countermeasures.

Government Order No. 11/1999 Coll., defines for the licensee the following requirements:

- for the elaboration of a proposal for establishing an emergency planning zone for the nuclear facilities or workplaces with a significant source of ionizing radiation (in accordance with Section 17 of the Atomic Act the licensee shall submit this proposal to SÚJB for the determination of the emergency planning zone size),
- for ensuring the activity of National Radiation Monitoring Network in the emergency planning zone,
- for the provision of the population in the emergency planning zone with antidotes,
- for ensuring the press and information campaign for the population in the emergency planning zone for the cases of radiation accident,
- for the notification system of involved bodies about occurrence or suspected occurrence of a radiation accident,
- for ensuring the warning system of population in the emergency planning zone.

Further requirements are laid down by the Act No. 239/2000 Coll., on the integrated rescue system and on amendments to some acts, as amended and by the Act No. 240/2000 Coll., on crisis management and on amendments to some acts, as amended by the Act No. 320/2002 Coll.

Act No. 239/2000 Coll., as amended, establishes:

- General definition of the extraordinary event, which is not identical (is broader) with the term “radiological emergency”,
- Powers and means communication system of subjects ensuring rescue and remedial work as an urgent part of the response to an extraordinary event in the place of the extraordinary event and on the territory endangered by affects of the extraordinary event (Integrated Rescue System),
- Way of control and coordination of activities of basic and other units of the integrated rescue system during rescue and remedial work, its coordination in the place of intervention carried out by the intervention officer, operational coordination and strategic coordination by state bodies, bodies of regions and municipalities with an extended competency,
- Powers and duties of bodies and representatives of regions, municipalities with an extended competency and municipalities in the case of extraordinary events occurrence within their territorial scope, including power of requesting assistance of superior bodies and units of the Integrated Rescue System,
- Rights and duties of legal and physical entities during the preparation for extraordinary events and during rescue and remedy work and during the population protection during extraordinary events including radiation accidents,
- Division of responsibility and tasks among bodies of region, bodies of municipalities with an extended competency, municipalities and Fire Rescue Services of regions for the preparation of basic documents, elaboration and approval of off-site emergency plans for performance of rescue and remedial work and the population protection for emergency planning zones at nuclear installations and objects, and installations with hazardous substances.

Act No. 240/2000 Coll., as amended, establishes the competence and power of state bodies and bodies of the self-governing administrative territories, and rights and duties of legal and physical entities during the preparation for crisis situations and during their resolution. The Act establishes bodies of crisis management and solves the issues of the safety councils to ensure the crisis preparedness for the cases of extraordinary events occurrence and of the Emergency Headquarters for the cases of their occurrence. The Act establishes requirements for the elaboration of crisis plans of the central state administration bodies, territorial state and self-governing administration bodies, and in case of crisis situation declaration. The Act further establishes rights and duties of legal and physical entities during the preparation for crisis situations and during their resolution.

Implementing legal regulations were added to the above-mentioned acts, which are, among others, related to emergency preparedness assurance and crisis management in the field of utilization of nuclear energy and ionizing radiation. The relevant details are amended by:

- **Ministry of Interior Decree No. 328/2001 Coll.**, on some details in ensuring of the integrated rescue system, as amended by the Decree No. 429/2003 Coll.,

- **Ministry of Interior Decree No. 380/2002 Coll.**, for the preparation and performance of tasks for population protection,
- **Government Order No. 462/2000 Coll.**, for the implementation of Section 27 paragraph 8 and Section 28 paragraph 4 of the Act No. 240/2000 Coll., as amended by the Government Order No. 36/2003 Coll.

Ministry of Interior Decree No. 328/2001 Coll., establishes details for ensuring integrated rescue system operation, including principles for coordination and collaboration of its units during common intervention. The Decree further establishes requirements for the contents of documentation of the integrated rescue system, way of elaboration of documentation and details on alarm degrees of the alarm plan. The Decree also establishes principles and way of elaboration, approval and use of regional emergency plan and off-site emergency plan, as well as the principles of crisis communication and connection within the integrated rescue system.

The off-site emergency plan, which is the emergency plan developed for the emergency planning zone, is broken-down into: information section, operations section and plans of specific activities.

Information section includes:

- a) general description of the nuclear installation or workplace of the category IV,
- b) characteristics of the territory, in particular data on demography, geography, climatic conditions and description of infrastructure on the territory,
- c) list of municipalities, including the overview on the number of population, and list of legal and other responsible person included in the off-site emergency plan,
- d) analyses results of possible radiation accidents, and possible radiological effects on the population, animals and environment,
- e) classification system of radiation accidents in accordance with the on-site emergency plan,
- f) requirements for the population and environment protection in relation to intervention levels during the radiation accident,
- g) description of the emergency preparedness organizational structure in the emergency planning zone, including a listing of competencies of its components for the performance of necessary activities, and
- h) description of a notification and warning system, which includes the relations to licensee and information transfer within the emergency preparedness organization in the emergency planning zone.

Operations section includes:

- a) tasks of administration offices, municipalities and components having relation to countermeasures included in the off-site emergency plan,
- b) way of radiation accident resolution coordination,
- c) criteria for the declaration of corresponding crisis situations, in case the off-site emergency plan does not suffice for the radiation accident resolution,
- d) way of securing information flows during the radiation accident consequences remedial management and
- e) principles for activities during the spreading or the possibility of spreading of radiation accident consequences outside the emergency planning zone and cooperation between

administration offices and municipalities having relations to countermeasures included in the off-site emergency plan.

Plans of specific activities establish procedures for the implementation of the individual measures for the following areas:

- a) notification,
- b) warning of population,
- c) rescue and remedial work,
- d) sheltering of the population,
- e) iodine prophylaxis,
- f) evacuation of persons,
- g) individual protection of persons,
- h) decontamination,
- i) monitoring,
- j) regulation of persons movement and transport,
- k) traumatological plan,
- l) emergency plan for veterinary measures,
- m) regulation of food, feedstuff and water distribution and consumption,
- n) measures in case of death of persons in the contaminated area,
- o) public order and safety ensuring,
- p) communication with the public and mass information media.

The **SÚJB Decree No. 380/2002 Coll.**, establishes, among others, details in the manner of informing legal and physical entities on the nature of the possible threat, upcoming measures and the way of their implementation, details of technical, operational and organizational plans ensuring a unified warning and notification system as well as a way of providing emergency information.

The **Government Order No. 462/2000 Coll.**, establishes in particular identification details, record mode determination, handling and filing of documents and other materials containing special facts; procedure for designation of persons to contact with special facts; structure and activity of the Security Board of the region and municipality specified, and the Emergency Headquarters of the region and municipality specified; details of the emergency plan and emergency preparedness plan, and way of their elaboration.

11.1.2 Implementation of emergency preparedness measures, including role of the State Supervision Body and other departments

Emergency response organization (OHO)

In accordance with the SÚJB Decree No. 318/2002 Coll. the operator of the nuclear power plant (licensee) is obliged, in order to assure emergency preparedness, to create corresponding organizational and personal conditions so that in case of extraordinary events occurring the personnel of the nuclear power plant are ready to respond immediately to the situation and to commence preplanned activities aimed at eliminating the negative effects and consequences.

The Emergency Response Organization has been established both at the Dukovany locality and at the Temelín locality, which consists, during the early stage of extraordinary event development when it is required to provide for the activities related to the initial assessment of

significance, notification of the extraordinary event, mobilization of intervening persons as well as operational management and implementation of intervention, of the continuous shift operation personnel only.

Shift engineer

In case of extraordinary event occurrence the shift engineer is responsible for the management of the extraordinary event until the shift engineer relegates the responsibility to the Shift Emergency Headquarters mobilized. The Shift engineer activities during the extraordinary event occurrence adhere to the intervention instruction, which includes all responsibilities and powers, which of the most important are: assessment of extraordinary event significance - classification, provision of a notification and warning of the NPP personnel and warning within the emergency planning zone, notification of nuclear power plant top management and relevant bodies and organizations on extraordinary event occurrence, decision on the Shift Emergency Headquarters activation, decision on protective countermeasures for NPP personnel.

Operational MCR personnel

The MCR personnel having the basic workplace at the relevant MCR assure the control of each unit in case of an extraordinary event occurrence. In case the MCR is uninhabitable, or loss of the possibility of control of unit technology, the MCR personnel perform their activities from the ECR. Safety engineer responsible for extraordinary event management at the unit affected by an extraordinary event is transferred to support the personnel of this unit of the Dukovany NPP.

Other shift personnel

Other continuous shift operation personnel in case of an extraordinary event, depending on the significance degree, either proceeds with the activities in accordance with the instructions of the operational MCRs personnel to the extent of descriptions of its job positions, or gathers, in case of the declaration of protective countermeasures, in the operational support center, from where, based on the instructions of the shift engineer or the Shift Emergency Headquarters, the required interventions in technology are carried out or the operative support is created to the unit of the NPP Fire Rescue Service during clearing and rescue works.

Emergency Headquarters (EH)

The Emergency Headquarters is the main managing workplace of the NPP emergency response organization. The Emergency Headquarters secures, after its activation, the management of activities of all employees and other persons participating in intervention work when eliminating development and solving consequences of an extraordinary event at NPP. The Emergency Headquarters ensures the communication with the external emergency preparedness units.

The Emergency Headquarters (EH) is established for the reason of prompt availability for action during management of the emergency response organization in case of the occurrence, duration and removal of extraordinary event consequences. Main tasks of the SEH, as a managing body, are to manage all activities in the NPP, to transfer information to superior and supervision bodies, to inform the public and to declare the protective countermeasures for NPP employees and other persons present on the NPP premises at the time of the extraordinary event occurrence. The SEH controls the activities of the operationally established intervention groups during the liquidation of extraordinary event effects and consequences. The SEH secures the deliveries of necessary material, special means, and alternating the personnel as well as its maintenance and supplies.

Emergency Headquarters structure

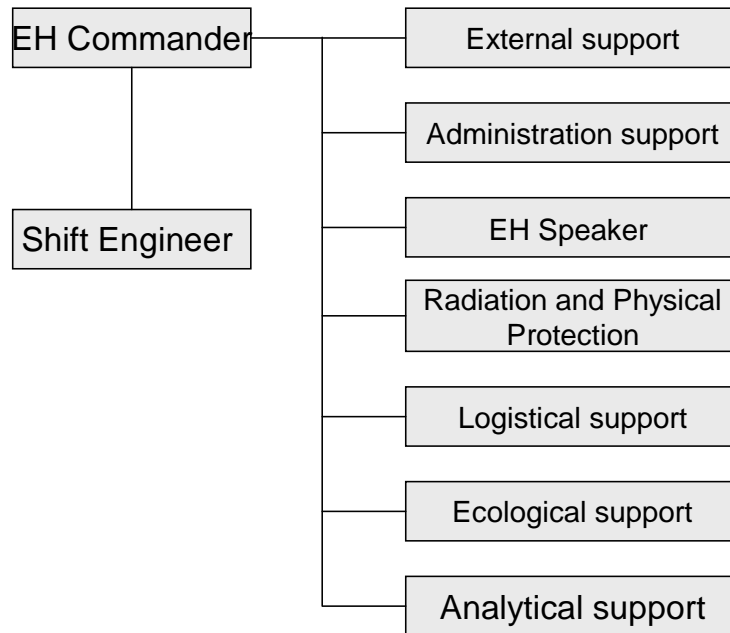

Technical Support Center (TSC)

The Technical Support Center personnel are made up of experts of technical departments (safety, dosimetry, operation, and information). The Technical Support Center is staffed to be able to provide qualified technical support to the personnel of the main control room of the affected unit during extraordinary events management.

The TPS personnel also ensures immediate evaluation of nuclear power plant safety condition in consideration of nuclear safety and radiation protection; has control over the activity of operative intervention groups during management of extraordinary event consequences; and prepares basic documents and recommendations for decision-making and control activities of the Emergency Headquarters.

Technical Support Center structure

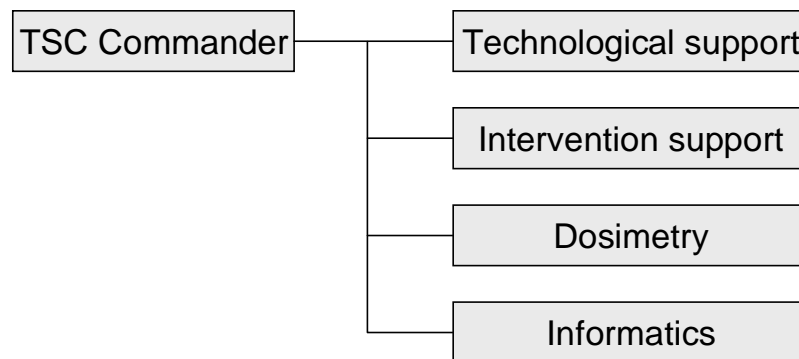

In the emergency preparedness system the emergency support centers represent specially prepared and equipped workplaces designed to secure the support of activities of personnel involved in the emergency response organization. Employees involved in the emergency response organization are obliged to participate in special theoretical and practical preparation aimed at acquiring activities determined by the on-site emergency plans and relevant intervention instructions.

Classification degrees of extraordinary event

To assess significance of extraordinary events, which may occur during the performance of radiation activities on a nuclear installation, these events are classified in three basic degrees (SÚJB Decree No. 318/2002 Coll., Section 5):

- extraordinary event of the first degree is an event which results or may result in an inadmissible exposure of employees and other persons or inadmissible release of radioactive substances into the premises of a nuclear installation or workplace. A first degree event may be a radiation incident, it has a limited and local character and may be sufficiently addressed with human and material resources available to the operating personnel or shift personnel, and no release of radioactive substances into the environment occurs during transport,
- extraordinary event of the second degree is an event, which results or may result in inadmissible serious exposure of the employees and other persons or in inadmissible release of radioactive substances into the environment, which do not require introduction of urgent countermeasures to protect population and the environment. A second degree event may be a radiation incident requiring mobilization of licensee's intervening persons and which may be sufficiently addressed with human and material resources available to the licensee or human and material resources contracted by the licensees,
- extraordinary event of the third degree is an event, which results or may result in an inadmissible serious release of radioactive substances into the environment, requiring introduction of urgent countermeasures to protect population and the environment, as specified in the off-site emergency plan and region emergency plan¹⁾. A third degree event is a radiation accident and in addition to mobilization of licensee's intervening persons and intervening persons under the off-site or region emergency plans, involvement of other relevant bodies is required to address it.

National crisis preparedness and response systems

In accordance with the legal regulations, in particular in the area of emergency management, a structure of the crisis preparedness system was established in the Czech Republic for the case of crisis situations of different types. Fig. 11-1 shows the basic diagram of the structure of the crisis preparedness system for the case of a radiation accident.

In case of a radiation accident occurrence in the country or abroad with a possible impact on the Czech Republic territory, the occurring crisis situation is being solved within the crisis (accident) response system, the basic diagram of which is given in the Fig. 11-2.

Fig. No. 11-1

Basic diagram of the Czech Republic emergency preparedness structure for the case of an extraordinary event occurrence

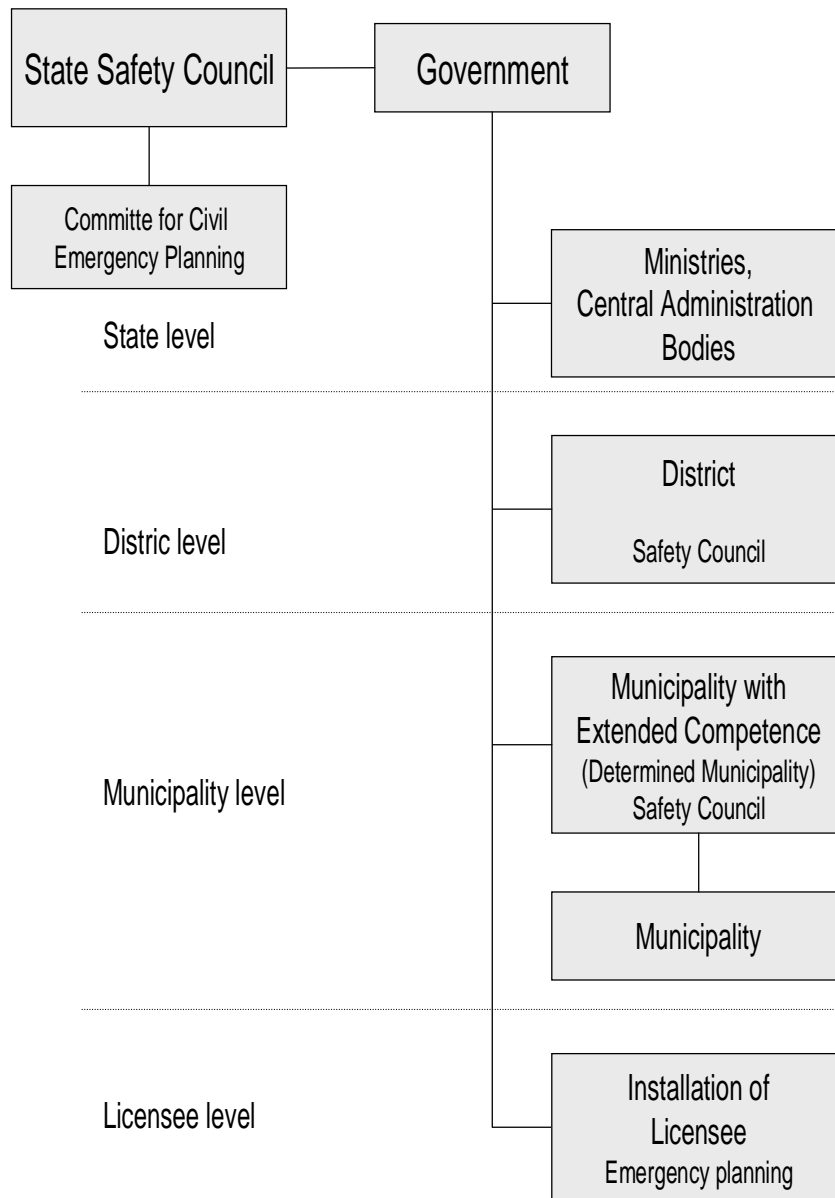
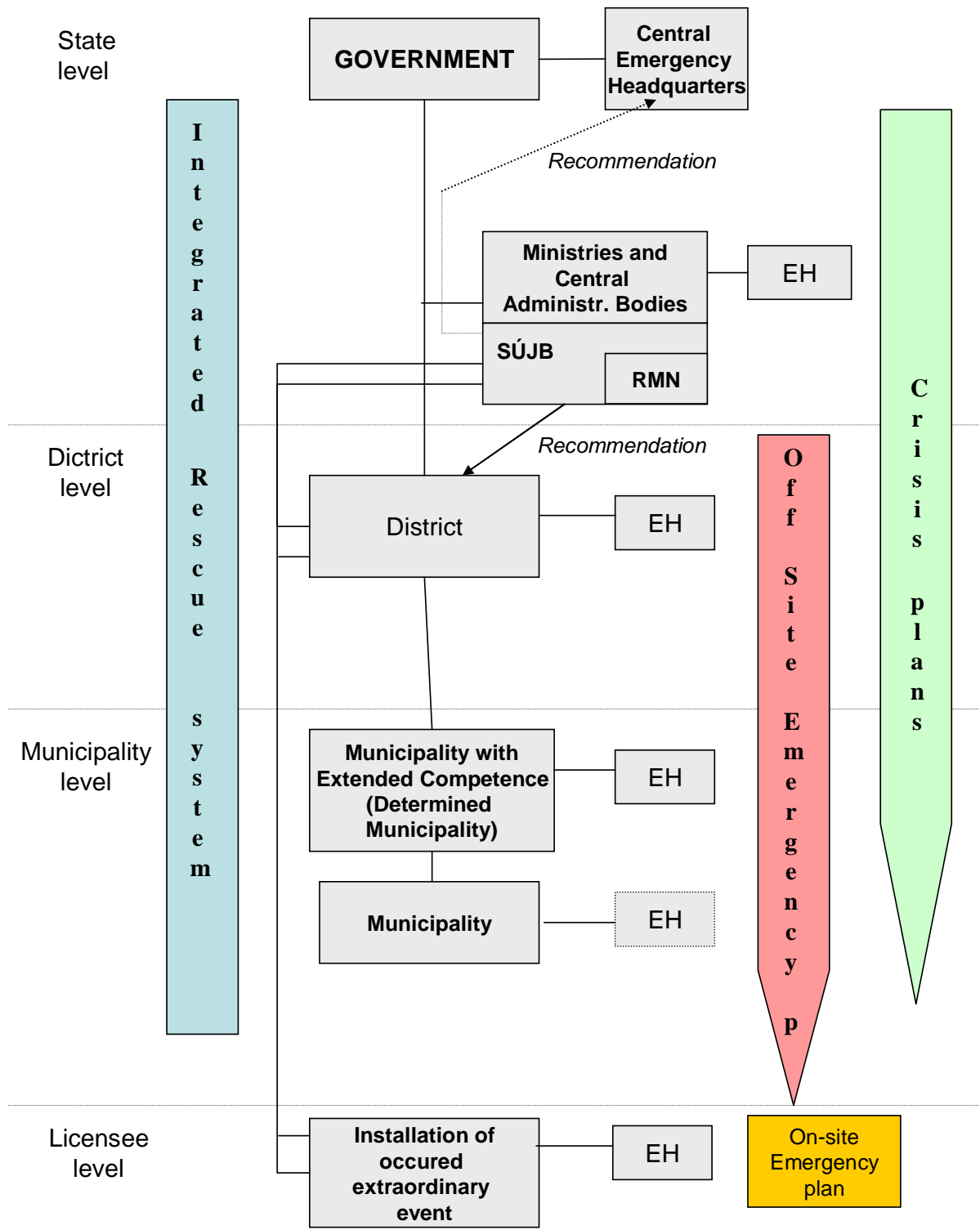

Fig. No. 11-2

Basic diagram of the Czech Republic emergency response structure during a radiation accident occurrence



The Czech Republic government is the highest body, responsible for the crisis situations preparedness and in case of their occurrence for their solution in the territory of the Czech Republic. In the constitutional Act No. 110/1998 Coll., on the Czech Republic security, the State Safety Council was established. In linkage to this Act, the government specified the activities and structure of the National Security Council (BRS) by Czech Government Decree No. 391, of June 10, 1998 on the National Security Council (BRS) and on planning of measures to secure the safety of the Czech Republic specified the activities of the National Security Council (BRS), as amended, and specified its main tasks in the area of emergency preparedness and emergency situation management.

The government by the above mentioned Decree No. 391 of June 10 1998, as amended, has established a Committee for Civil Emergency Planning (VCNP) as a standing National Security Council working body for the coordination and planning of measures to secure the protection of national security, population and economics, critical infrastructure, to assure preventive measures to prevent use of nuclear, biological and chemical weapons including elimination of consequences of their use and to coordinate requirements on the requirements for civil resources necessary for security of the Czech Republic.

Issues in the area of planning and preparedness for the case of radiation emergency occurrence come within the competence of the Civil Emergency Planning Committee and the areas of radiation accident solution within the competence of the Central Emergency Headquarters, which acts as a governmental body for the resolution of crisis situations.

The main tasks in the area of the VCPN competence are specified by the VCPN Statute and especially focused on the following:

- operative interdepartmental coordination of planning and preparatory activities,
- assessment and discussion of planning, conceptual and preparatory activities, presented by the central bodies of the state administration,
- assessment and discussion of requirements of the central bodies of the state administration for the civil resources,
- discussion and evaluation of interdepartmental amendment procedures for materials and submission of their discussions within the State Safety Council,
- assessment, discussion and coordination of the activities of the Czech Republic representatives in the NATO authorities and in other international subjects,
- processing and coordination of activities in the area of humanitarian aid and rescue works.

The Minister of Interior is the Chairperson of the Committee for Civil Emergency Planning; the Deputy Minister of Interior is the Executive Deputy Chairperson and the deputy ministers of 12 departments, the SÚJB Chairperson, the Vice-Governor of the Czech National Bank, the Chairperson of the Administration of the State Material Reserves, the Director of the National Security Authority and the Director of the National Security Council are other members of this Committee.

For securing the solution of occurred crisis situations including the radiation accidents on a national level a working body of the State Safety Council, the Central Emergency Headquarters is established. The chairman of the Central Emergency Headquarters is the Minister of Interior. The members of the Central Emergency Headquarters are deputy ministers and top managers of other central bodies of state administration including the SÚJB

Chairperson.

The Central Emergency Headquarters is also activated both in case of radiation accidents of a nuclear installation outside the Czech Republic territory with the possibility of impact on the Czech Republic, and during radiation accidents occurred during the transport of nuclear materials and radioactive substances.

On-site and off-site emergency plans of nuclear installations

On-site emergency plans of nuclear installations (licensees) are prepared in compliance with requirements for emergency preparedness assurance, and in the extent established by the SÚJB Decree No. 318/2002 Coll., as amended by the Decree No. 2/2004 Coll. The plans establish the following:

- organizational structure of the licensee and principles for management and implementation of interventions in the event of an extraordinary event occurrence. In this connection, the plans define the duties of persons and on-site organizational departments and units in case of an extraordinary event declaration, classified in accordance with their significance to the individual degrees of the classification system (refer to classification of extraordinary events),
- methods of announcement of persons and units of the licensee, and other external units and bodies which have to be called in to perform an intervention within the nuclear installation (licensee) premises,
- methods of notification of the SÚJB and state administration bodies (Regional Authorities and municipalities with extended competence, to the territory of which extends the emergency planning zone) on the occurrence of an extraordinary event of 1st and 2nd degree, and in the event of an extraordinary event of 3rd degree - radiation accident - the methods of their notification and ensuring of warning of the public within the emergency planning zone,
- requirements for the radiation situation monitoring in case of extraordinary event occurrence both for the nuclear installation (licensee) premises and for its vicinity. The plans establish methods of notification and warning of the personnel and persons present in the nuclear installation (licensee) for the individual degrees of extraordinary events, and necessary measures are specified there for the protection of their health and lives, and for the limitation and reduction of their irradiation. These plans define principles and procedures of gathering, sheltering, evacuation, providing emergency medical firstaid to all employees and persons affected, including medical provision and specialized medical care,
- procedures during the termination of the extraordinary events,
- procedures for management and implementation of interventions for designated persons and departments of a nuclear installation (licensee), including security of the protection of employees and persons established by the on-site emergency plan, as well as procedures for the notification of bodies and organizations affected by the on-site emergency plan, are processed in form of intervention instructions. The latter ones specify activities after the declaration of the corresponding degree of an extraordinary event including the necessary technical, instrumental, and material assurance.

Off-site emergency plans for the nuclear installations are elaborated by the respective Fire Rescue Services of regions in accordance with the requirements specified in Act No. 239/2000 Coll., as amended, and by the Ministry of Interior Decree No. 328/2001 Coll., as amended by

Decree No. 429/2003 Coll., for the specified emergency planning zone. The off-site emergency plan is developed on the basis of documents handed over by the licence holder and on the basis of partial documents prepared by respective regional authorities, units and municipalities.

Developed off-site emergency plans are discussed with the licence holder and with the respective central administration bodies, i.e. with SÚJB and the Ministry of Interior – General Directorate of Fire Rescue Service of the Czech Republic.

The off-site emergency plans set down targets and methods of ensuring the individual types of protective countermeasures:

- notification of bodies and organizations,
- warning of people,
- sheltering people,
- evacuation of people, including dosimetric checks and decontamination at the exits from the endangered territory,
- regulation of persons movements within the endangered territory,
- health care.

Warning of the public within the emergency planning zone

After the Regional Authorities and municipalities with extended competency have been notified, the most important measure of both NPPs for the protection of the public is a warning of the public within the emergency planning zone which is with reference to on-site emergency plan ensured by NPPs. Warning of the public is assured within the whole emergency planning zone, formed by a territory 20 km around the Dukovany NPP and 13 km around the Temelín NPP. The public is warned by a signal of sirens with following radio and TV broadcasting (transmissions) of the prepared initial information on the radiation accident occurrence, and on the countermeasures to be carried out (sheltering, iodine prophylaxis - taking KI tablets) and recommendation on the preparation for evacuation of people within 5 km internal zone around Temelín NPP and within 10 km internal zone around Dukovany NPP.

Iodine prophylaxis (KI tablets) is distributed in advance to the population within the emergency planning zone (households, schools, hospitals, and workplaces), when the Regional Authorities have approximately 10 % reserve of KI doses, and these preparations are on sale in pharmacies. The KI tablets held by the public are regularly exchanged by the licensee before their expiration date. Simultaneously the "Public Protection Manual" is distributed to the public within the emergency planning zone, which includes the basic information on activities of the public in case of radiation accident.

Fig. No. 11-3

Schematic representation of the public warning system within the emergency planning zone

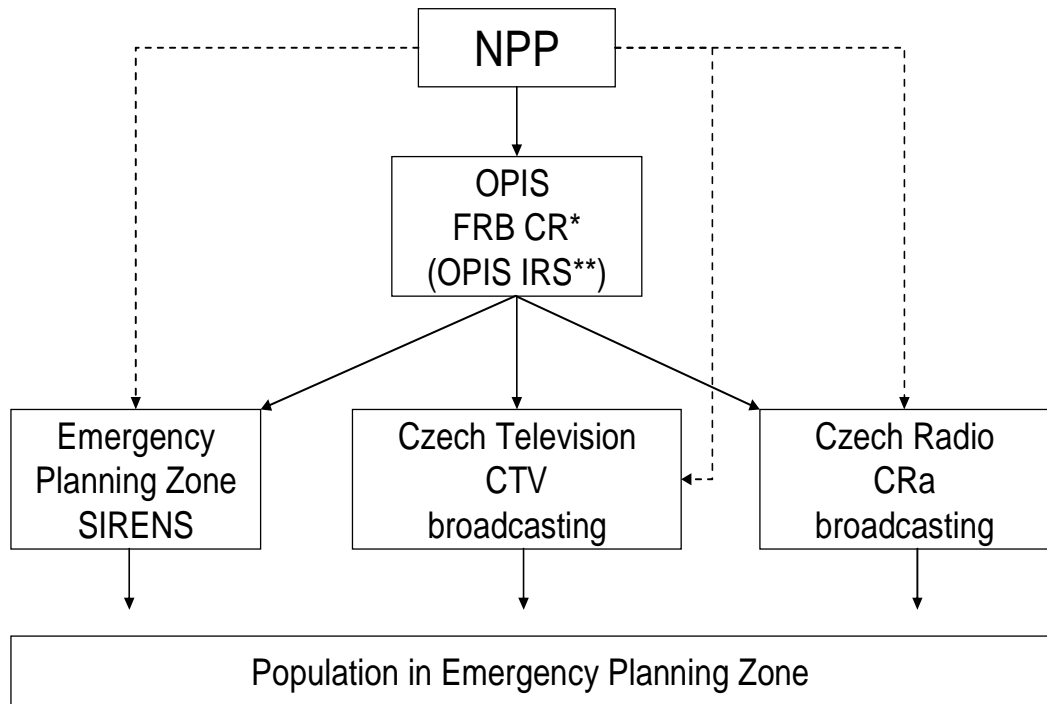

In accordance with Section 3 of the Atomic Act, the SÚJB provides, based on the evaluation of the radiation situation in the case of radiation incidents and accidents, background documents for the decision-making about measures leading to the mitigation or elimination of irradiation in case of a radiation accident. These background documents are elaborated by the SÚJB Emergency Headquarters based on information submitted from the affected nuclear installation and from data provided by the National Radiation Monitoring Network; the SÚJB Emergency Headquarters carries out its activities in the premises of the SÚJB Emergency Response Center. In the sense of the Crisis Act, the SÚJB Emergency Response Center is thus a crisis management workplace.

In case of an extraordinary event occurrence when using the background documents for the support of the decision making process, concerning the protective countermeasures using hardware, methodical and software tools located in the Emergency Response Center, the Emergency Headquarters, among others:

- evaluates the technology status development in relation to measures implemented by the nuclear installation operators,
- evaluates the radiation situation in the nuclear installation,
- elaborates, in collaboration with the Czech Hydrometeorological Institute, the prognoses of radioactive substances dispersion from the location of radiation accident occurrence, and information about a possible threat in the nuclear installation vicinity based on the meteorological situation and its presumed development,

- specifies the "source term" of the radioactive substances release and the extent of the affected territory.

The SÚJB Emergency Headquarters submits the elaborated background documents, depending on the size of the affected territory, to the Central Emergency Headquarters and to the Regional Emergency Headquarters.

The SÚJB Emergency Headquarters in cooperation with the Operations and Information Center of the Ministry of Interior – General Directorate of Fire Rescue Service of the Czech Republic (OPIS MV-GŘ HZS ČR) ensures:

- notification of the IAEA within the meaning of the "Convention on Early Notification of a Nuclear Accident" and the "Convention on Assistance in the Case of a Nuclear and Radiation Accident" and contact points of the countries based on the closed international bilateral agreements, when continuous operation of the contact point for information transmission is ensured by the Operations and Information Center of the Ministry of Interior – General Directorate of Fire Rescue Service of the Czech Republic (OPIS MV-GŘ HZS ČR),
- notification of the EU within the meaning of the Council Decision No. 87/600/Euratom,
- providing the public with information.

Measures for providing the public with information, including emergency preparedness in nuclear installation vicinity

In the frame of informing the public within the emergency planning zones of both NPPs, the licensees prepared and the SÚJB approved the documents "Public protection manual for the case of a radiation accident at Dukovany NPP" and "Public protection manual for the case of a radiation accident at Temelín NPP", distributed by the NPPs each household.

The manuals contain information on the procedure the public shall follow after the warning signal within the emergency planning zone in case of the need for sheltering, application of iodine prophylaxis, and declaration of evacuation preparation, including determined evacuation routes depending on the meteorological situation. The NPPs provide the population each year with abridgement of these manuals in the form of a wall calendar.

The public receives information also at the "Information Centers of the Nuclear Power Plants", and the NPPs and SÚJB take on request of the relevant Regional Authorities part in the information campaigns organized by the Regional Authorities.

11.1.3 Training and exercise

Nuclear power plants have developed plans for the theoretical and practical training of their employees and other persons and units related to the occurrence of an extraordinary event of different degrees. Special plans of theoretical and practical training are prepared for persons and units assigned in the on-site emergency plan for management and implementation of interventions, with emphasis on their activities during an extraordinary event of a relevant degree, in accordance with the intervention procedures established by the on-site emergency plan as well as their developed intervention instructions. Exercises are carried out according to the yearly exercises plans aimed at verifying the management and implementation activities starting from the moment of an extraordinary event occurrence, in accordance with the established intervention procedures and intervention instructions.

Emergency preparedness in the emergency planning zone in accordance with the off-site emergency plan is also being verified, once in three years at a minimum, with help of exercises, in which units defined by the off-site emergency plan for the case of an extraordinary event of the 3rd degree participate.

Exercises of the off-site emergency plan for the specified emergency planning zone are organized similarly in three activity phases:

Preparatory: a scenario is elaborated for the scheduled exercise, establishing:

- goal, scope and duration of the exercise
- determination of the model radiation accident, its development and process,
- specification of the emergency response procedures,
- specification of intervening units and hardware engagement for the emergency response,
- determination of persons, who will evaluate the exercise and exercise observers,

Implementation: the proper process of the exercise according to the prepared scenario in presence of all bodies, organizations and individual persons, responsible for the management and implementation of interventions, including the activities of the persons performing the evaluation or the exercise observers,

Evaluation: elaborated in form of final protocol; protocols are filed as proof of the scheduled emergency exercise evaluation for long-term storage; for each calendar year all performed partial emergency exercises are evaluated in summary; the deficiencies, discovered during the exercise, are applied at:

- changes, modifications or detailing of the off-site emergency plan,
- amendments and modifications of emergency response intervention procedures,
- preparation of bodies, organizations and persons managing or implementing interventions during emergency response,
- assition of hardware, equipment and material,
- amendments or modifications of organizational assurance of the emergency response

Coordination emergency exercises of ČEZ, a. s

The coordination emergency exercises together with the Integrated Rescue System units and other bodies defined in the off-site emergency plan, which are described in the last National Report of the Czech Republic, continued in the period 2004 – 2006 as follows:

Name of exercise	Site	Date
Horizont 2004	Dukovany NPP	23 JUNE, 2004
Podzim 2004	Temelín NPP	23 SEPTEMBER, 2004
ČAS	Dukovany NPP	29 JUNE, 2005
MU of 3rd degree	Temelín NPP	28 JUNE, 2006
Smaragd 2006	Dukovany NPP	13 SEPTEMBER, 2006

All coordination exercises were performed based on the approved Emergency Exercise Plans submitted to SÚJB. The subject matter of the coordination emergency exercises was to verify

the activities of personnel of the Dukovany NPP, or the Temelín NPP, emergency response organization as well as to practice the declared countermeasures (sheltering, evacuation) for the employees. Further the exercises verified the collaboration of both NPPs with the units of the integrated rescue system of the Czech Republic according to the principles indicated in the on-site and off-site emergency plans. The system of works organization of the individual units of the crisis management was practiced during the exercises.

The exercises were successful, they fulfilled their goals as well as the program, and proved good preparedness of the individual units of the emergency organization of the Dukovany NPP, or the Temelín NPP, for the solution of situations, the probability of occurrence of which is very unlikely.

In 2007 two similar coordination emergency exercises will take place – the first one in Dukovany NPP and the second one in Temelín NPP.

11.2 Statement on the implementation of the obligations concerning Article 16 of the Convention

The Czech Republic has adopted and implemented all measures ensuring that nuclear installations have regularly verified on-site and off-site emergency plans, and which cover activities to be performed in the case of an accident. The plans are prepared and verified before the nuclear installation begins its operation above the minimum level of power established by the Regulatory Body. At the same time, such measures are taken which ensure that the public of the Czech Republic as well as the competent bodies of states in the vicinity of nuclear installation, which may be feasibly affected by a radiation accident occurred in the nuclear installation on the territory of the Czech Republic, received the corresponding information for the preparation of emergency plans and mitigating interventions.

12. Siting - Article 17 of the Convention

Each Contracting Party shall take the appropriate steps to ensure that appropriate procedures are established and implemented:

- (i) for evaluating all relevant site-related factors likely to affect the safety of a nuclear installation for its projected lifetime;*
- (ii) for evaluating the likely safety impact of a proposed nuclear installation on individuals, society and the environment;*
- (iii) for re-evaluating as necessary all relevant factors referred to in subparagraphs (i) and (ii) so as to ensure the continued safety acceptability of the nuclear installation;*
- (iv) for consulting Contracting Parties in the vicinity of a proposed nuclear installation, insofar as they likely to be affected by that installation and, upon request providing the necessary information to such Contracting Parties, in order to enable them to evaluate and make their own assessment of the likely safety impact on their own territory of the nuclear installation.*

12.1 Description of the current situation

12.1.1 Description of the licensing process, including a summary of national legislation

The description of the licensing process in general - for siting, designing, construction, operation and decommissioning of a nuclear installation is included in chapter 2.1.2 of the present National Report. The legislative framework applicable for issuing the site approval from the aspect of nuclear safety and radiation protection is represented by the Atomic Act and its implementing regulations:

- **SÚJB Decree No. 215/1997 Coll.**, on criteria for siting of nuclear installations and very significant ionizing radiation sources,
- **SÚJB Decree No. 214/1997 Coll.**, on quality assurance in activities related to the utilization of nuclear energy and in radiation practices, and establishing criteria for the classification and categorization of specified installations into safety classes,
- **SÚJB Decree No. 307/2002 Coll.**, on radiation protection, as amended by the SÚJB Decree No. 499/2005 Coll.,
- **SÚJB Decree No. 144/1997 Coll.**, on physical protection of nuclear materials and nuclear installations and nuclear facilities and their classification, as amended.
- **SÚJB Decree No. 309/2005 Coll.**, on assurance of technical safety of selected equipment

As further mentioned in chapter 3.1.2, siting of a nuclear installation is one of the activities, to which SÚJB has to issue an approval in accordance with the provision of Section 9 of the Atomic Act, from the nuclear safety and radiation protection point of view. For issuing the approval under Section 13 of the Atomic Act, the following preconditions apply:

- an environmental impact assessment according to the Act No. 100/2001 Coll., on environmental impact assessment,
- an approval of the quality assurance program for the activity being authorized.

Application for the nuclear installation siting must be, in accordance with the Appendix A of the Atomic Act, documented by the following documentation:

I. Initial Safety Analysis Report, the content of which shall include:

- description and evidence of suitability of the selected site from the aspect of siting criteria for nuclear installations and very significant ionizing radiation sources as established in an implementing regulation,
- description and preliminary assessment of the design concept from the viewpoint of requirements laid down in an implementing regulation for nuclear safety, radiation protection and emergency preparedness,
- preliminary assessment of the nuclear installation operation impact on the personnel, the public and the environment,
- proposal of concept for safe decommissioning,
- assessment of quality assurance in the process of the selection of site, the method of quality assurance for preparatory stage of the construction and the quality assurance principles for linking stages.

II. Analysis of needs and possibilities to provide physical protection

The SÚJB Decree No. 215/1997 Coll. establishes criteria for the assessment of the particular site suitability from the aspect of nuclear safety and radiation protection. At the same time, protection of other interests, resulting from the valid legislation, remains preserved. This Decree defines the exclusion and conditioning criteria.

Exclusion criteria are those limiting characteristics, which unequivocally exclude utilization of a particular region for siting nuclear installations. These criteria include radiological impacts of the planned installation on its vicinity under normal operating conditions and radiation emergency, as well as effects of the site on nuclear safety and radiation protection of the same installation.

Conditioning criteria are such characteristics, which make an area or land suitable for siting nuclear installations under the condition that it is feasible or technically possible to offset the unfavorable regional conditions, both natural and the ones caused by human activities.

In the implementing SÚJB Decree No. 195/1999 Coll., on basic design criteria for nuclear installations with respect to nuclear safety radiation protection and emergency preparedness, and particularly in the SÚJB Decree No. 215/1997 Coll., on criteria for siting of nuclear installations and very significant ionizing radiation sources, IAEA recommendations and guidelines for nuclear installations siting are taken into account.

The above mentioned implementing regulations of the Atomic Act, in accordance with the IAEA recommendations, require that assessments within the siting process should consider the historically most significant phenomena registered in the particular locality and its vicinity, as well as a combination of natural phenomena, phenomena resulting from human activity and accident conditions due to these phenomena. Within the siting and design, nuclear installations must be evaluated as to their resistance against the following natural phenomena and phenomena initiated by human activity:

- earthquakes,
- climatic effects (wind, snow, rainfall, outdoor temperatures, etc.),
- floods and fires,
- air crash, and flying and falling objects
- explosions of industrial, military and transport means, including explosions in nuclear installations buildings,
- release of dangerous and explosive fluids and gases.

Based on probabilistic assessment some of these events may be excluded when the probability of their occurrence is very low. It is in the SÚJB competence to establish such limiting values for each of those cases.

12.1.2 Measures for fulfillment of the siting criteria for nuclear installation

12.1.2.1 Dukovany NPP

Geographic position of the site

The Dukovany NPP is located in the south-eastern part of the region of Třebíč, to the southwest from the Brno city on the right bank of the Jihlava river. The location of the site within the Czech Republic is shown in the map in the Fig. 1-1 (chapter 1). The power plant is located 45 – 50 km from the state border with Austria, with the shortest air distance to the border being 35 km. The northern part of the region is a broken stretch of land with Jihlava river valley, in the southern part it changes into a plain. The region altitude varies from 369 up to 711 m above sea level. There are five smallish towns in the nuclear power plant vicinity – Třebíč, Náměšť nad Oslavou, Moravské Budějovice, Moravský Krumlov, and Jaroměřice nad Rokytnou. Brno city, with approximately 500,000 inhabitants, including suburban concentrations, is situated 35 km northeast of the plant. Approximately 108,000 people live within 20 km. Population density in other parts of the territory is very low, with only small settlements.

The site has been selected in a way to minimize possible interactions of the nuclear installation with the adjacent territory. Thus, in the immediate vicinity there are no large industrial facilities or frequented transport routes. Density of industrial facilities near Dukovany NPP is significantly lower than in other parts of the Czech Republic territory. The immediate vicinity of the nuclear power plant has an unequivocally agricultural character, and there are only a few small industrial works.

Protection against earthquake

Seismic assessment has been performed for the area determined by a circle with a radius of 200 km having its center in the nuclear power plant.

Geological surveys and knowledge of the bedrock under the cooling towers foundations are assessed as adequate. Surveys of the area under the reactor buildings I and II and the adjacent buildings were even assessed as adequate for one hundred percent. Constructions classified in the 1st category of seismic resistance (such as the reactor buildings) of the nuclear power plant are founded on a high quality underlying rock with the underground water below the level of foundations. The very high surface spring constant of the elastic bearing 200 MPa/m in the vertical direction and 140 MPa/m in the horizontal direction corresponds to a high quality bedrock, on which the reactor building is founded. Geological maps, geological profiles and

the borehole characteristics are attached to the reports used for the preparation of the Pre-operational (Final) Safety Report for the Dukovany NPP.

At the Dukovany site, the greatest possible effects of an earthquake may be expected, according to historical data, from the Alps seismic focuses. It results from analyses considering both the greatest possible magnitude of shocks and the most adverse attenuation of intensities from distances in the direction of seismic focus – that the Dukovany site has entirely theoretically a maximum of macro-seismic intensity, which may be expected of 6° MSK. Calculation of the seismic risk has resulted in the limiting value of macro-seismic intensity of 5.8° MSK, which should not be exceeded even within 10,000 years period.

The region of interest, Dukovany NPP, is continuously monitored by the local seismic station Kozének and its records are continuously seismically evaluated by the Energoprůzkum Praha s. r. o. and local seismic station KRUC, records of which are evaluated on a continuous basis by the Masaryk University in Brno – Institute of Physics of the Earth.

Analyses performed at the same time confirmed the non-existence of any local tectonic activity. Actually no observed effects of any earthquakes were reported for Dukovany village. Closest local activities originated in Jindřichův Hradec area, where epicentral intensities did not exceed 5° MSK-64, and the macro-seismic fields of which did not reach the Dukovany region.

Based on the above details using the most conservative approach, the following seismic characteristics may be obtained:

- design basis earthquake is equal to the maximum historically observed earthquake in the area, i.e. 6° MSK-64,
- safe shutdown earthquake is equal to the maximum estimate of the maximum possible expected earthquake, i.e. 6° MSK-64 + 0.5° MSK-64 (error in the determination of intensity).

It results unambiguously from the above-mentioned assessment that due to seismically entirely calm area and stability of the bedrock, the Dukovany NPP cannot be endangered by a seismic event. Despite that, as a contribution to safety, maximum conservative approach has been used, and in compliance with the IAEA recommendations and considering the results presented above, level SL-1 equals to 6° MSK-64 and level SL-2 equals to 0.1 g acceleration (which is in the conditions of Central Europe a very highly conservative estimate of the safe shutdown due to earthquake) were specified for the Dukovany site.

Protection against floods and adverse climatic phenomena

The largest river in the vicinity is the Jihlava river, at the north of the nuclear power plant, from which service water is taken and into which the waste water is discharged. The power plant site is located approximately 100 m above the maximum levels. On the Jihlava river, near the nuclear power plant a system of waterworks Dalešice – Mohelno, forming a pumped-storage hydro-electric power plant, was built. Jihlava river flow at the in-flow to waterworks Dalešice varies around the average annual value of $6 \text{ m}^3 \text{ s}^{-1}$.

An analysis of floods and prediction scenarios of floods show that the locality of the Dukovany NPP, in consequence of its position on a high plain lying on a higher level than the crests of dams of waterworks Dalešice – Mohelno, never was, and is not endangered even now, by floods.

Specific knowledge of the meteorological situation in the vicinity of the nuclear power plant is necessary to determine the influence of cooling towers and to assess the radioactivity spread; therefore special attention was paid to accumulate such knowledge. The nuclear power plant vicinity is located within the Atlantic-continental area of temperate climatic zone of the Northern Hemisphere. Here, in the course of a year, air masses of oceanic and continental origin alternate, which is connected with frequent passages of atmospheric fronts. Specific meteorological measurements and observations at the site have been carried out continuously by the meteorological observatory of the Czech Meteorological Institute at Dukovany since June 1982. For its regular synoptic and climatological measurements the observatory uses standard meteorological instruments.

Adverse meteorological conditions for the locality in question, such as windstorms, precipitation and extreme temperatures have been taken into account in the design.

Protection against effects caused by aircraft crash

The airspace above the nuclear power plant has been proclaimed prohibited for all flights in the document "Flight Information Manual" which is binding on all users of the Czech Republic airspace.

The nuclear power plant is located in a close vicinity of military airfield Náměšť (approximately 10 km). The space above the nuclear power plant with a radius of 2 km and height of 1500 meters is a prohibited space for airplanes.

Probabilistic as well as deterministic analyses of the possibility and consequences of an aircraft crash of various categories were carried out. The analyses have shown that the power plant is sufficiently protected against the effects caused by both a military and a civil aircraft. Assessment of the protection against the effects caused by an aircraft crash was performed in accordance with the IAEA instructions. The results of the calculations have shown that the aircraft crash will not cause inadmissible destruction of the primary system because its civil structures, important for nuclear safety, are sufficiently resistant against possible impacts of such a crash. The analyses have also shown that the spatially isolated backed-up core cooling systems, together with civil protective structures, ensure that even an aircraft crash will not affect the function of the reactor emergency shutdown and cooling.

Protection against explosion pressure waves

Near the Dukovany NPP, at a distance of about 500 meters, there is a second-class road (No. 15) – Brno, Ivančice, Dukovany, Jaroměřice nad Rokytnou, Moravské Budějovice. Other roads in the vicinity are less frequented. The analyses have shown that even in the case of a very improbable explosion of a transport vehicle carrying a dangerous freight, plant safety will not be affected in any way.

The plant has a single-line railway from the eastern direction of Moravský Krumlov and Brno. The probability of a train accident of trains carrying dangerous freight, both in present and in long-term prospect is practically zero.

In the plant vicinity, there are no external sources of potential danger. The analyses have shown that a potential explosion of hydrogen during its transport and storage, which represents the predominant source of possible explosions within the Dukovany NPP premises, will not endanger equipment important for safety so that the safety function of the equipment will not fully fail. Higher attention is paid to the handling of hydrogen storage bins located outside the reactor units in order to minimize the possibilities of hydrogen escape.

Protection against influence of third parties

The nuclear power plant design takes into account also the protection against the influence of third parties. Safety systems are redundant and spatially distant, the same is valid for their power supply. This engineered safety is supplemented with technical, organizational and regime system of measures, which shall prevent the inadmissible influence of third parties.

12.1.2.2 Temelín NPP

Geographic position of the site

The Temelín site was selected at the turn of the seventies/eighties as a result of the evaluation of the parameters of the territory established by the ČSKAE Decree No. 4/1978 Coll., valid at that time. Location of the site in the Czech Republic is shown in the map in the Fig. 1-1 (chapter 1). The power plant is at a distance of 45 – 50 km from the state borders with Austria and the Federal Republic of Germany. The nearest permanently inhabited locality is the village Temelín - at a distance of 2 km in northwest direction. The distance from Týn nad Vltavou with approximately 8,300 inhabitants is 5 km, and from the Vodňany town with 6,700 inhabitants is 14 km. The České Budějovice city is at a distance of 25 km and its population is approximately 100,000. Approximately 260,880 persons live within a radius of 30 km around the nuclear power plant, according to general census of the population in 2001. Population density in other parts of the territory is very low. Only small settlements prevail here.

Again, the site has been selected in a way as to minimize possible interactions of the nuclear installation with the adjacent territory. Thus, in the immediate vicinity there are neither large industrial facilities, with exception of the pipeline of the transit gas line, nor frequented transport routes. The density of industrial facilities in South Bohemia is significantly lower than in other parts of the Czech Republic territory. The immediate vicinity of the nuclear power plant has an unequivocally agricultural character, and there are only a few small industrial works. No industrial development in 10 km area in the perspective up to 2020 is planned.

Protection against earthquake

Despite the fact that the Czech Republic territory belongs among the geologically well surveyed territories, another detailed assessment of the geological underlying rock up to the distance of 30 km from the nuclear power plant had been performed in relation with the nuclear power plant siting. The original geological surveys performed during the eighties have been supplemented by 1991 – 1994 surveys in accordance with the IAEA recommendations.

The geological bedrock of the locality is represented by South-Bohemian branch of the Molanubikum and the South-Bohemian basins. Both units belong to the Bohemian massif, which was created by the end of Paleozoic Era in the final phase of Varisk rock forming cycle. The most frequent rocks here are gneiss, granites and quartz. The plant site has a rock substratum; the main buildings of the power plant are positioned on a homogeneous block with a size exceeding 500 x 500 m. Geomechanically, the plant underlying rock has a sufficient foundation bearing capacity for buildings and equipment of the nuclear power plant.

Seismic assessment has been performed for the whole area under interest, delimited by a circle of a 300 km radius having its center in the power plant. The biggest part of this area lies within the Bohemian massif territory, in the south and southeast it reaches the Alps-Carpathian region. The Moldanubikum under the NPP is the oldest and strongest part of the

Bohemian massif. The seismic risk value is determined by Alps earthquakes. Results of the seismologic analyses show that there are no known cases of local tectonic shocks.

The earthquake catalogue was supplemented in accordance with the IAEA recommendation 50-SG-S1 rev. 1. It is one of the important reference documents of the Pre-operational (Final) Safety Report, and starts with the year 1550.

The Temelín NPP zone of interest is continuously monitored by local seismological network with five stations, records of which are evaluated on a continuous basis by the Masaryk University in Brno – Institute of Physics of the Earth.

It results from the assessments based on the greatest possible shocks in the focus areas located in the concerned area and most adverse attenuation of intensities with the seismic focus far distant – the NPP's limiting value of macro-seismic intensity which should not be exceeded with 0.95 probability even within 10,000 years period is 6.5^o MSK-64, which corresponds to 0.1 g in the conditions of Central Europe. The design acceleration was 0.1 g, which is fully conforming to the IAEA recommendations issued in 1991. These values have been used both in the design and construction of the buildings and equipment necessary to ensure a safe shutdown of the reactor, removal of residual heat and prevention of radioactive substance releases (classified in the category 1 of seismic resistance). The IAEA expert mission took place in 2003 (see Chapter 1.1.3.1).

Protection against external floods and adverse climatic phenomena

Operation of the power plant is primarily dependent on the Vltava river, from which service water is taken and into which the waste water is discharged. Vltava river represents a main axis of the Czech river system, and a number of water reservoirs which had been built on it years ago, forming the so called Vltava river cascade, it serves to protect against flooding and some of them help to generate hydroelectric power. A significant benefit provided by the cascade reservoirs is the equalization of the minimum flows. For the needs of the NPP Temelín, two water reservoirs were added to this cascade: Hněvkovice from which process water is taken, and Kořensko, which is used to mix the discharged waste water with Vltava water.

Analysis of floods and prediction scenarios of floods show that the locality of the Temelín NPP has never been flooded, and is not endangered by floods. The main plant buildings, housing equipment important for nuclear safety, are built at the altitude of 510 m above sea level. It results from the assessment of historic extreme flows that the power plant area is approximately 150 m above the maximum levels. The site has been also assessed from the aspect of possible destruction of water reservoirs on the upper course of the Vltava river.

Specific knowledge of the meteorological situation in the vicinity of the nuclear power plant is necessary to determine the influence of the cooling towers and to assess the radioactivity spread; therefore special attention was paid to accumulate such knowledge. The vicinity of the nuclear power plant is located within the Atlantic-continental area of temperate climatic zone of the Northern Hemisphere. Here, in the course of a year, air masses of oceanic and continental origin alternate, which is connected with the frequent passages of atmospheric fronts (average of 125 fronts a year). Prevailing are such meteorological situations when fronts come from the west, in a lesser degree – from the north. The specific meteorological measurements at the site have started at the time when the meteorological observatory was being built. The observatory is located at a distance of 3 km from the nuclear power plant in the northwest direction. The measurements were started in April 1988, and are carried out

continuously since January 1989.

Adverse meteorological conditions for the locality in question, such as windstorms, precipitation and extreme temperatures have been taken into account in the design.

Protection against effects caused by aircraft crash

The airspace above the nuclear power plant with a radius of 2 km and height 1500 m has been proclaimed prohibited for all flights by the "Flight Information Manual". The nearest flight corridor is situated 18 km from the power plant. Thus, air traffic has no effect on the nuclear power plant. The military airfield at Bechyně, located 25 km from the plant, was liquidated.

Calculations have shown that the power plant is protected against the effects caused by a military and civil aircraft crash. An assessment of these effects was performed in accordance with the International Civil Aviation Organization (ICAO) guidelines. The results of the calculations have shown that an aircraft crash would not cause inadmissible destruction of the primary system because its civil constructions, important for nuclear safety, are sufficiently resistant against possible impacts of such a crash. The analyses have also shown that the spatially isolated back-up core cooling systems, together with civil construction, ensure that even an aircraft crash will not affect function of the reactor emergency shutdown and cooling.

Protection against explosion pressure waves

In the vicinity of the nuclear power plant three branches of the transit gas line of 1400, 1000 and 800 mm diameter are situated. Their minimum distance from the plant reactor buildings is about 900 m. Transit gas line transports natural gas. Analyses have shown that even the maximum postulated accident on the gas line (simultaneous break of all three branches) would not impair the functions of the buildings and technological equipment. A series of measures was adopted to reduce the probability of a pipe accident occurrence and for the mitigation of possible consequences. The principal ones are the additional implementation of spherical valves, shortening of isolable gas pipe sections, and also a system for natural gas leakage monitoring. Calculations and analyses performed by professional organizations and research institutes were assessed positively by the SÚJB.

At the southeast boundary of the site is a frequented secondary road No. 105 České Budějovice – Týn nad Vltavou. Other roads in the plants close vicinity are less frequented. At a distance of more than 10 km, there are two sections of international roads used also for transportation of hazardous freights (ARD). However, the analyses have shown that even in case of a very improbable explosion of a transport vehicle carrying dangerous freight, the plant safety will be not affected.

The nearest railway situated about 1.4 km from the power plant is the local railway line Číčenice – Týn nad Vltavou with passenger and goods trains. Passenger trains are very infrequent. On this line, the probability of an accident of trains carrying dangerous goods both at present and in long-term prospect is practically zero.

Protection against influence of third parties

The nuclear power plant design takes also into account protection against the influence of third parties. Safety systems are redundant and spatially distant, the same is valid for their power supply. This engineered safety is supplemented with technical, organizational and regime system of measures preventing the inadmissible influence of third parties.

12.1.3 Activities leading to the preliminary assessment of nuclear energy installations siting

The SÚJB Decree No. 215/1997 Coll., requires that the impacts of the external events mentioned above should be re-evaluated, either after a certain time of operation or within the framework of the regular revisions of the safety documentation, applying most advanced scientific and technical tools and taking into account any changes which have occurred in the locality.

This impact re-evaluation has been performed over a ten-year period representing the period for which the license for a nuclear power plant operation is issued in the Czech Republic. Issues related to siting criteria are also the subject of periodic safety evaluation performed in accordance with the IAEA document No. NS-G-2.10 Periodic Safety Review of NPP.

12.1.4 Assessment of environmental impact of a nuclear power plant

The environmental impact of the Dukovany NPP was minimized and it is permanently observed, monitored and controlled. The priority of the power plant management is a protection of a healthy environment documented by the introduction of the Environment Management System (EMS), which was re-certified by the company Det Norske Veritas in November 2003. This periodic audit found a correspondence with the standard EN ISO 14001, and approved thereby an authorization to hold the certificate issued based on the Dutch accreditation RvA recognized worldwide. The Environment Management System was introduced and certified also in the Temelín NPP, similarly to the Dukovany NPP, in 2004.

In the Temelín NPP the environment components are monitored in compliance with the requirements of the legislation and, besides, according to a special extended Program of Environmental Impact Monitoring and Assessment already for many years. This allowed obtaining basic information prior to putting the power plant into permanent operation, which will be used for reference levels. For details, refer to Chapter 10 "Radiation protection".

The above-mentioned "Program of Environmental Impact Monitoring and Assessment", which has been performed since 2000, covers all environmental areas, i.e. atmosphere and climate, surface waters, soil, geo-factors and underground waters, agro systems, ionizing radiation and the public. The program was elaborated by the company Investprojekt Brno and the individual areas were elaborated by the representatives of Universities and research Institutes. The employees of the Academy of Sciences of the Czech Republic represented opponents of the proposal for the "Program". The program was approved in 1999 and the Temelín NPP assures its fulfillment starting from the subsequent year. The environmental status before the Unit 1 commissioning, i.e. by 2000, was evaluated, the data statistically processed and it forms the "zero", in other words pre-operational, environmental status. Data measured after the putting of Unit 1 into operation are and will be related to this status.

The results of the monitoring and assessment are summarized each year in an annual report, elaborated by the individual solving parties of the "Program", and issued annually in a summary report. Its sponsor is the Water Research Institute.

During construction, in accordance with the newly adopted legislation, the Environmental Impact Assessment (EIA) was performed for all substantial design changes. The Ministry of the Environment issued a positive opinion to this assessment.

In addition, in the frame of the Melk protocol closed in December 2000 between the prime ministers of the Czech Republic and Austria with the presence of the EU commissioner for the enlargement. Another assessment of the nuclear plant impact on the environment was performed in the time period January – June 2001. This assessment was performed in accordance with the applicable EU regulations dealing with the assessment of the impact of projects on the environment.

Possible impact was monitored in the following areas:

- climate and atmosphere,
- hydrology,
- geology and seismicity,
- impact on the population health,
- influence on the nature and landscape,
- wastes (including the radioactive ones) and possibilities of emergencies.

The Commission appointed by the government of the Czech Republic and having performed the assessment concluded that "the environmental impact of the Temelín NPP is small, insignificant and acceptable". In the conclusion, the Commission recommended 21 measures aimed in particular at intensifying the monitoring of all influences during the future plant operation. The measures are continuously fulfilled and regularly assessed.

Both EIA processes were accompanied by a proper public hearing, where all questions and comments raised by the public of the Czech Republic, Austria and Germany were answered.

12.1.5 International agreements with neighboring countries

In accordance with bilateral intergovernmental agreements with the Federal Republic of Germany and with Austria, the Czech Republic submits to the governmental bodies of these states information on its nuclear installations, situated near common borders. Information is transferred regularly, during annual bilateral meetings (yearly meetings), and irregularly, within the agreed meetings, or in writing.

During the above-mentioned Melk process, during which also Temelín NPP safety issues were discussed, an unprecedented amount of information was submitted to the Austrian party concerning the design, safety analyses, and the analyses of the environmental impact of the operation. In the safety issues area, the Czech Republic cooperates also with other neighboring countries, in particular with the Federative Republic of Germany.

The Czech Republic has also signed a general intergovernmental agreement on the exchange of information from the field of the utilization of nuclear energy with other neighboring countries.

12.2 Statement on the implementation of the obligations concerning Article 17 of the Convention

Legislation of the Czech Republic establishes the relevant procedures for assessment of all factors important for safety of a nuclear installation in relation to its siting and for assessment of its probable environmental impact. At the same time, it introduces the regular re-evaluation regime for all important parameters – within the periodic assessment of nuclear safety assurance, while applying the up-to-date technical tools and knowledge and taking into account any changes, which occurred in the locality. It also follows that requirements of the legislation were implemented into the practice.

The requirements of Article 17 of the Convention are fulfilled in the Czech Republic.

13. Design and construction - Article 18 of the Convention

Each Contracting Party shall take appropriate steps to ensure that:

- (i) the design and construction of a nuclear installation provides for several reliable levels and methods of protection (defense in depth) against the release of radioactive materials, with a view to preventing the occurrence of accidents and to mitigating their radiological consequences should they occur;*
- (ii) the technologies incorporated in the design and construction of a nuclear installation are proven by experience or qualified by testing or analysis;*
- (iii) the design of a nuclear installation allows for reliable, stable and easily manageable operation, with specific consideration of human factors and the man-machine interface.*

13.1 Description of the current situation

13.1.1 Description of the licensing process including a summary of the national legislation

A general description of the licensing process for siting, design and construction, operation and decommissioning of a nuclear installation is the content of the chapter 2.1.2.

The legislative framework governing the issue of a construction permit which covers the nuclear safety and radiation protection aspects is established by the Atomic Act and its implementing regulations, in particular:

- **SÚJB Decree No. 195/1999 Coll.**, on basic design criteria for nuclear installations with respect to nuclear safety radiation protection and emergency preparedness,
- **SÚJB Decree No. 214/1997 Coll.**, on quality assurance in activities related to the utilization of nuclear energy and in radiation practices, and laying down criteria for the assignment and categorization of classified equipment into safety classes,
- **SÚJB Decree No. 309/2000 Coll.**, on assurance of technical safety of selected equipment,
- **SÚJB Decree No. 307/2002 Coll.**, on radiation protection, as amended by the SÚJB Decree No. 499/2005 Coll.,
- **SÚJB Decree No. 144/1997 Coll.**, on physical protection of nuclear materials and nuclear installations and nuclear facilities and their classification, as amended.

As further mentioned in chapter 3.1.2, construction of a nuclear installation is one of the activities to which SÚJB has to issue an approval in accordance with the provision of Section 9 of the Atomic Act, from the nuclear safety and radiation protection point of view. For issuing the nuclear installation construction permit under Section 13 paragraph 5 of the Atomic Act, the following preconditions apply:

- approval of a quality assurance program for the approved activities,
- approval of a quality assurance program for the design.

Application for an approval for a nuclear installation construction must be in accordance with the Appendix B of the Atomic Act documented by the following documentation:

I. Pre-operational (Final) Safety Report, the content of which shall include:

- evidence that the proposed solution, given by the design, meets all requirements for nuclear safety, laid down in implementing regulations,
- safety analyses,
- data on the presumed lifetime of the nuclear installation,
- concept of a safe termination of operation and decommissioning of the approved nuclear installation, including nuclear waste disposal,
- concept of spent nuclear fuel management,
- assessment of quality assurance during preparation for construction, method of quality assurance for the carrying out of construction work and principles of quality assurance for linked phases,
- list of classified equipment.

II. Physical protection assurance proposal.

After positive assessment of the above documentation SÚJB will issue the construction permit, whilst the list of classified equipment and physical protection assurance proposal are subject to a separate approval by the SÚJB.

13.1.2 Dukovany NPP

Basic nuclear safety principles included to the nuclear power plant design, including the application of the defense-in-depth strategy

Technological description of the Dukovany NPP units is given in the Annex 1.

The safety criteria and principles on which the original design was based were included into the Russian Contract design – "Technical Substantiation of Safety". The design criteria are here narrowed down to one basic nuclear safety criterion:

"NPP design must provide for the protection of operators and the public from outer and inner irradiation and surrounding environment from contamination by radioactive substances within approved standards. This should be assured both during long-term stationary operation and anticipated accident conditions."

Other criteria were established only implicitly as references to technical standards of the former USSR. The document "Technical Substantiation of Safety" (1974) served as a basis and already before putting of the Dukovany NPP into operation a series of Czech and Russian normative regulations, which were taken into account when elaborating the original technical design into the particular design of the Dukovany NPP, was issued.

When comparing the provisions of the above binding regulations during the series of analyses performed for units with the VVER-440/213 reactors at the beginning of the nineties with the current requirements for design documentation, it is possible to state that the Czechoslovak legislation of the eighties (and in principle also the regulations of the former USSR, which were subjected to similar development) was on a very good level. Generally, the requirements conformed to the contemporary understanding of nuclear safety, and principles and criteria included in the legislation, to a considerable extent, coincide with the current ones.

The technical design defined the so-called "design basis accident" – double ended rupture on the cold leg of the primary circuit (nominal diameter 500 mm) in the inseparable part of the reactor inlet.

The design considers technical and organizational measures to assure nuclear safety in the event of a single failure of the normal operating equipment simultaneously with an undetected long-term failure of other normal operating equipment. Simultaneously with the normal operating equipment failure, the failure of one independent safety division is investigated. The safety analyses included in the Safety Analysis Reports are performed for the defined and verified set of initiating events.

The Dukovany NPP design respects the defense-in-depth concept defined in the IAEA document INSAG-3 and its revision INSAG-12. It is based on several protection levels, which include the consecutive physical barriers, preventing radioactive release into the environment:

- Level 1: Conservative design, design quality and safety culture,
- Level 2: Control of deviations from the normal operation and detection of failures,
- Level 3: Safety systems and protection systems,
- Level 4: On-site emergency management and radioactive leakage detection system,
- Level 5: Off-site emergency planning.

The most complex international assessment of VVER-440/213 units, in the light of defense-in-depth implementation, has been performed within the Extra budgetary IAEA program in the period of 1991 - 1998 (see chapter 1). The program was organized with the objective to identify deviations of the VVER-440/213 design from the current safety standards. Safety significance of the individual equipment (system) was assessed on the basis of its contribution to the defense-in-depth degradation. Output document [1-6] of the program comprised also recommendations for elimination of established deviations.

From these general findings, the Dukovany NPP has subsequently selected the ones relevant for the Dukovany design, and has elaborated a program of measures for their elimination. The majority of the corrective measures have been already implemented before the elaboration of the National report (all of them with higher priority). An international group of experts within the framework of the IAEA mission in 1996 organized for that purpose, has positively assessed the program of corrective measures implementation (refer to [1-7]).

The results of the Dukovany NPP design assessment, Pre-operational (Final) Safety Report and its periodic revisions, and successful implementation of the corrective measures program are considered as one of the main evidences that the design and the construction of the nuclear installation provide several reliable protection levels and approaches (defense-in-depth) against radioactive material release aimed at preventing accidents and mitigating their possible radiological consequences.

Human factor and man - machine interface related design features

The operation of the Dukovany NPP units has unequivocally proved that the design of this nuclear installation ensures its reliable, stable and easily controlled operation. Over the years, the plant underwent a number of modifications made with the objective to minimize the possibility of a human factor error and to improve the man-machine interface, especially in the process control system. Additional modifications are scheduled within the Modernization Program of the Dukovany NPP (refer to the Annex 5). These modifications were implemented, or are focused both on the main control rooms and on the simplification of

regular performance tests of individual equipment. Some of the modifications increase the share of automatic control and thus contribute to the reduction of the number of necessary operator interventions and consequently to the reduction of the number of potential human errors.

For a reliable and safe operation with emphasis on human factor and man-machine interface, both the design and the technical tools of the main control rooms are very significant. The main control room concept in the VVER-440/213 units, in its Dukovany NPP specific modification and renovated within the I&C system renovation project, provides:

- very good overview of the equipment condition, fast and easy orientation of the main control room personnel during normal operation as well as during transients. The original situation has been improved further by changes in the instruments ergonomic design implemented as a result of the operators initiative,
- easy and fast equipment control from the main control room,
- appropriate design of the failure and emergency warning systems which contributes to timely and correct identification of failures. Innovations were implemented with emphasis on improvement of the man-machine interface,
- appropriate combination of analogy (classic) type signaling and control of the main control room with digital elements – computer based equipment, which is implemented to the main control room. More extensive computerization in the main control room improves the personnel's work efficiency and has a favorable effect on the man-machine interface and thus limits possible errors due to "human factor". This concerns in particular a series of supporting computer programs performing auxiliary calculations enabling to utilize the documentation in digitized form, etc.

13.1.3 Temelín NPP

Basic principles of nuclear safety included in the nuclear power plant design, including application of the defense-in-depth strategy

Technological description of the Temelín NPP units is given in the Annex 1 to the National Report.

At the present time the design is completed and modified so that both units have been on a level fully comparable with up-to-date nuclear power plants as to the level of nuclear safety assurance and other properties.

The basic design of the Temelín NPP units 1 and 2 was elaborated by the Czech design organization Energoprojekt (EGP) Praha. Already before 1989, the inland experts have analyzed and modified the original design. Further technical improvements have resulted from the IAEA expert opinions, SÚJB recommendations, proposals from the future operator and from many Czech experts and from the results of the External Audit performed by the company NUS Halliburton. Their implementation brought the technical level of units 1 and 2 of Temelín NPP into compliance with western nuclear power plant standards according to requirements of the end of the nineties.

Design changes were then verified and are further verified by new analyses performed with advanced computer codes, both in depth and structure conform to the requirements of international standards. Significant changes of the design are described in the chapter 1.1.3.2.

To reach and to maintain the required level of nuclear safety, the Temelín NPP is designed to be compliant with generally applicable national and international regulations for nuclear

safety assurance, and fulfils following safety principles and functions:

- capability to shutdown safely the reactor and to maintain it in conditions of safe shutdown under all operating modes and events anticipated in the design,
- capability to remove residual heat from the reactor core under all operating modes and events anticipated in the design,
- capability to minimize any possible leakage of radioactive matter in a way not to exceed the stated limits in all operating modes and events anticipated in and after the design.

Observance of these general principles is achieved by adhering consistently to the defense-in-depth principles and by fulfilling safety functions as described in the IAEA Safety Standards and in the INSAG 12 document. Personnel and the vicinity of the nuclear power plant are protected against consequences of any severe accidents by physical barriers comprised of:

- nuclear fuel matrix (practically all fission products are retained within the matrix of the uranium dioxide pellets),
- fuel rods cladding (fuel cladding is made to remain hermetic over the whole time of utilization and thus preventing the fission products release),
- primary circuit (reactor pressure vessel and the primary circuit represent a barrier resistant to pressure load, heat and radiation exposure),
- containment – pre-stressed concrete dome (external 1.2 m thick containment covers the reactor and all important primary circuit equipment, and thus prevents radioactivity releases into the environment in the event of an accident related with the integrity damage of the preceding barriers).

In 1996, a special mission of the IAEA checked how the innovated design of the Temelín NPP reacts to the IAEA safety issues, generic for nuclear power plants with VVER-1000/320 reactors described in the IAEA document [1-15], [1-16].

Individual safety issues were, similarly as in the case of units with VVER-440/213 type reactors, categorized in accordance with the defense-in-depth possible violation viewpoint. The mission evaluated the design, implementation of modifications recommended earlier, and the preparation for operation, including the issue of the design compatibility (implementation of western technology into the original design). The mission recognized a general improvement of the Temelín NPP design. The mission emphasized that the combination of eastern and western technology was considered with great care. In some cases combination of eastern and western technology led to a higher safety improvement compared to international practice.

In November 2001, repetitive mission review took place aimed at solving safety findings identified by the IAEA in 1996.

In conclusion of the mission it was stated that the majority of recommendations were implemented in the Temelín NPP on a very good level. For a few issues, the intent of the IAEA recommendations has not yet been met in full. However all these pending issues have been addressed and measures are at an advanced stage of implementation to complete their resolution. These conclusions and positive result of the above-mentioned expertise confirm that the Temelín NPP design follows sufficiently the defense-in-depth concept. Simultaneously the mission stated that the Temelín NPP exceeds in some areas the usual safety standard.

The condition of the Czech nuclear legislation and implementation of the general safety-related requirements at power plants was compared with the IAEA requirements and recommendations within the activities of the Reactor Harmonisation Working Group of the WENRA countries in 2005-2006. The result of the assessment, which took place in all member countries to the WENRA, showed that Czech nuclear units are not backward of the comparable power plants of member countries from the viewpoint of the implementation of joint safety-related requirements.

13.2 Statement on the implementation of the obligations concerning Article 18 of the Convention

The legislation valid in the Czech Republic and its implementation in practice is compliant with the requirements of Article 18 of the Convention. The operated Dukovany NPP and Temelín NPP are designed with respect to the defense-in-depth concept against radioactive substance release with the goal to prevent occurrence of accidents and to mitigate their radiation consequences. Applied technologies are either well proven or verified by the tests combined with computational analyses.

14. Operation - Article 19 of the Convention

Each Contracting Party shall take appropriate steps to ensure that:

- (i) the initial authorization to operate a nuclear installation is based upon an appropriate safety analysis and a commissioning program demonstrating that the installation, as constructed, is consistent with design and safety requirements;*
- (ii) operational limits and conditions derived from the safety analysis, tests and operational experience are defined and revised as necessary for identifying safe boundaries for operation;*
- (iii) operation, maintenance, inspection and testing of a nuclear installation are conducted in accordance with approved procedures;*
- (iv) procedures are established for responding to anticipated operational occurrences and to accidents;*
- (v) necessary engineering and technical support in all safety-related fields is available throughout the lifetime of a nuclear installation;*
- (vi) incidents significant to safety are reported in a timely manner by the holder of relevant licence to the regulatory body;*
- (vii) programmes to collect and analyze operating experience are established, the results obtained and the conclusions drawn are acted upon and that existing mechanisms are used to share important experience with international bodies and with other operating organizations and regulatory bodies;*
- (viii) the generation of radioactive waste resulting from the operation of a nuclear installation is kept to the minimum practicable for the process concerned both in activity and in volume, and in necessary treatment and storage of spent fuel and waste directly related to the operation and on the same site as that of the nuclear installation take into consideration conditioning and disposal.*

14.1. Description of the current situation

14.1.1 Description of licensing process, including summary of national legislation

The description of the licensing process, in general for siting, designing and construction, operation and decommissioning of nuclear installation is given in the chapter 2.1.2.

The legislative framework for approval of the operation of a nuclear installation from the nuclear safety and radiation protection point of view is established by the Atomic Act and its implementing decrees, in particular:

- *SÚJB Decree No. 106/1998 Coll.*, on nuclear safety and radiation protection assurance during commissioning and operation of nuclear facilities,
- *SÚJB Decree No. 214/1997 Coll.*, on quality assurance in activities related to the utilization of nuclear energy and in radiation practices, and laying down criteria for the assignment and categorization of classified equipment into safety classes,

- *SÚJB Decree No. 307/2002 Coll.*, on radiation protection, as amended by the SÚJB Decree No. 499/2005 Coll.,
- *SÚJB Decree No. 144/1997 Coll.*, on physical protection of nuclear materials and nuclear installations and nuclear facilities and their classification, as amended,
- *SÚJB Decree No. 318/2002 Coll.*, on details of emergency preparedness of nuclear facilities and workplaces with ionizing radiation sources and on requirements on the content of on-site emergency plan and emergency rule, as amended by the Decree No. 2/2004 Coll.,
- *SÚJB Decree No. 185/2003 Coll.*, on decommissioning of nuclear installations and workplaces of categories III and IV.

As it was said in chapter 3.1.2, commissioning and operation of a nuclear installation are activities for which SÚJB authorization is required under the provision of Section 9 of the Atomic Act as to nuclear safety and radiation protection. According to Section 13 of the Atomic Act approval of a quality assurance program for the practice being licensed is a prerequisite for the issue of a license for commissioning and operation of a nuclear installation.

Commissioning

An application for the issue of authorization for the individual stages of nuclear installation commissioning must be, in accordance with the Appendix C of the Atomic Act, accompanied with the following documentation:

a) For stages prior to loading nuclear fuel into a reactor:

- Time schedule for work in a given stage;
- Program for the stage in question;
- Evidence that installation and personnel are prepared for the stage in question;
- Evaluation of results of the preceding stage;
- Method by which physical protection is to be provided.

b) For the first loading of nuclear fuel into a reactor:

I. Pre-operational (Final) Safety Report, which shall include:

- Description of changes of the original design assessed in the Preliminary Safety Report and evidence that there has been no decrease in the level of nuclear safety of the nuclear installation;
- Supplementary and more precise evidence of nuclear safety and radiation protection provisions;
- Limits and conditions for safe operation of the nuclear installation;
- Neutron-physics characteristics of the nuclear reactor;
- Method of radioactive waste management;
- Quality assessment of classified equipment.

II. Further documentation, which shall include:

- Evidence that all prior decisions and conditions of the SÚJB were fulfilled;
- Time schedule for nuclear fuel loading;
- Program for nuclear fuel loading;
- Evidence that installation and personnel are prepared for nuclear fuel loading;

- Evaluation of the results of previous stages;
- On-site emergency plan;
- Changes in the provision of physical protection;
- Program of in-service inspections;
- Proposed decommissioning method;
- Cost estimate for decommissioning.

c) For stages following the first nuclear fuel loading into the reactor:

- Time schedule for work in this stage;
- Program of this stage;
- Evidence that installation and personnel are prepared for the stage in question;
- Evaluation of results of the previous stage.

After a positive evaluation of the above-mentioned documentation, SÚJB issues the approvals for the individual phases of the reactor commissioning, whilst the program of the phases, proposed physical protection method, changes in physical protection assurance, proposed decommissioning method, on-site emergency plan, program of in-service inspections, as well as the Limits and Conditions for safe operation of a nuclear installation, are subject to a separate approval by the SÚJB.

Operation

Application for issuing the authorization for the nuclear installation operation must be, in accordance with Appendix D to the Atomic Act, accompanied with the following documentation:

- Supplements to the Pre-operational (Final) Safety Report and further supplements to documentation required for the issue of a license for the first nuclear fuel loading into the reactor, relating to changes carried out after the first nuclear fuel loading;
- Evaluation of results of previous commissioning stages;
- Evidence of implementation of previous decisions and conditions of the SÚJB;
- Evidence that installation and personnel are prepared for operation;
- Operation time schedule;
- Up-dated limits and conditions for safe operation.

After positive evaluation of the above-mentioned documentation, SÚJB issues the authorization for nuclear installation, whilst changes in the documentation, approved in previous stages, are subject to a separate approval by the SÚJB.

Although the authorization for operation under the Act is not time-limited, SÚJB issues during the operation, in accordance with the Section 9 paragraph 1 letter e), authorization for restarting a nuclear reactor to criticality after a nuclear fuel reload, based on review of the documentation submitted in accordance with Appendix E to the Atomic Act, i.e.:

- neutron-physics characteristics of the reactor;
- evidence that installation and personnel are prepared for restart of the nuclear reactor to criticality, including preliminary evaluation of in-service inspections;
- time schedule for subsequent operation.

14.1.2 Limits and Conditions for safe operation

Establishment of the Limits and Conditions for safe operation is required by the existing legislation – the Atomic Act and a set of its implementing decrees, as one of the basic documents for issuing authorization of the first nuclear fuel loading into the reactor and for subsequent operation of the nuclear installation.

The requirements of the Limits and Conditions for safe operation have been formulated as early as in 1982, following an initiative of the regulatory body. The concept was based on the US NRC reference guide [14-1] for nuclear power plants with pressurized water reactors.

Since that time, the Limits and Conditions have been systematically developed and details modified in accordance with the latest results of the development and research and with application of experience in operating individual NPP units.

The Limits and Conditions for safe operation form a set of uniquely defined conditions, for which it has been proved that the operation of nuclear installation is safe. Classification of the Limits and Conditions for safe operation is established in SÚJB Decree No. 106/1998 Coll., and includes the following data categories:

- Safety limits,
- Protection systems setting,
- Limiting condition for the operation (requirements for operation ability and acceptable values of parameters),
- Requirements for checks,
- Organizational measures,
- Reasons for the Limits and Conditions.

Such data establishes the values of physical and technological parameters affecting directly the condition of physical barriers, which prevent the leakage of radioactive substances, the setting of protection systems and the requirements for operation ability of equipment important from nuclear safety point of view.

In case any deviation from the Limits and Conditions occurs during the operation, responsible persons shall take immediate measures to restore the compliance as soon as possible. If the compliance cannot be restored and possible consequences of the deviation are significant for nuclear safety, the reactor must be put into state, in which the respective requirements of the Limits and Conditions do not apply. The operator is obliged to inform SÚJB on all deviations from the requirements of the Limits and Conditions, subsequently an analysis of the Limits and Conditions violation is performed and measures preventing repetition of such event are proposed.

Limits and Conditions of the Dukovany NPP

The first version of the Limits and Conditions for the Dukovany NPP units was put into use in 1983 as a first application for VVER reactors elaborated in accordance with the US NRC reference guide.[14-1] Since that time, the Limits and Conditions have been continuously developed and details modified. The Limits and Conditions were revised following an issue of the amended Atomic Act. These Limits and Conditions were put into force in 2001. The NUREG 1431 document was taken into account during the revision.

The document is still updated on a continuous basis and currently valid revision was approved by SÚJB early in 2005.

The requirements of the Limits and Conditions are based on the prerequisites of safety analyses, documenting the power plant safety at abnormal and emergency conditions (deterministic approach) and, when the limited technological system operation ability recovery time is fixed, they take the PSA results into account (probabilistic approach). The Limits and Conditions also reflect the calculation and experimental analyses and data, and are based on operational experience not only from the Dukovany units with the VVER 440/213 reactors, but also from similar units in other countries (Slovakia, Hungary, Russia).

Contents and internal segmentation of the Limits and Conditions are compliant with the requirements of the Atomic Act and the SÚJB Decree No. 106/1998 Coll. Justification of the Limits and Conditions are an integral part thereof. The Limits and Conditions are directly approved by the SÚJB and are also part of the Pre-operational (Final) Safety Report.

Limits and conditions of the Temelín NPP

Limits and conditions of the Temelín NPP were elaborated in accordance with the NUREG 1431 document and their requirements are based on the prerequisites of safety analyses, documenting the plant safety at abnormal and emergency conditions and consider conclusion of PSA. Contents and internal segmentation of the Temelín NPP Limits and Conditions are compliant with the requirements of the Atomic Act and the SÚJB Decree No. 106/1998 Coll. Limits and Conditions of the Temelín NPP are part of the Pre-operational (Final) Safety Report. The Limits and Conditions were approved by SÚJB as an independent document within the licensing procedure for the authorization of the first fuel loading into the reactor core. Limits and Conditions documentation, which is used by the plant personnel, is composed of two parts:

- 1) Limits and Conditions for safe operation
- 2) Substantiation of the Limits and Conditions for safe operation

Each system in the Temelín NPP is classified either as "important" or "unimportant" for the safety. Systems important for the safety are such systems, the availability for operation of which participates in the fulfillment of any of the safety functions. Systems important for the safety are divided in two subcategories, both of which are covered by the Limits and Conditions:

- 1) safety systems
- 2) safety related systems

Both these subgroups are covered with requirements of Limits and Conditions. Safety systems may further be classified as protection (actuating) systems, actuators (which are being actuated in case a certain predetermined value is exceeded) and supporting systems. Similarly it is possible to perform this division also for safety related systems. Here the actuators are controlled by control systems of safety related systems rather than by protection systems (limitation system, reactor control system etc.).

From the first fuel loading into the reactors of both units the approved Limits and Conditions were during the commissioning and during the trial operation, and now also in operation, several times modified with the changes approved separately. The necessity of performing these changes resulted from the performed approved equipment modifications and from the operational experience.

The whole document is revised on a periodic basis and currently valid revision became effective in January 2007, and is identical for both Temelín NPP units. At the same time the Limits and Conditions justification is continuously updated, which is an integral part of the

Limits and Conditions document.

14.1.3 Operation, maintenance, inspections and tests of nuclear installation

Operation

Units of both power plants are operated in accordance with internal decrees and the Limits and Conditions for safe operation. These documents are continuously and systematically updated and upgraded. The compliance with the documents is continuously monitored through the implemented control system and so called "feed-back" system (see chapter 14.1.7).

Internal audit of the electricity company ČEZ, a. s. in the Dukovany NPP has confirmed that the process of feedback from internal and external events (IRS-IAEA/NEA, WANO, VVER) is functional and effective. Internal audit did not propose any corrective measures or improvements of the current status. Temelín NPP verification by the OSART mission and the Follow up OSART mission in the field of feedback system did not find any significant deficiencies in the process of events investigation and corrective measures fulfillment. This was approved by another WANO mission in 2004 and the Follow-up WPR mission in 2006.

The system catches all necessary and usable events. The plant personnel are familiar with the system and the system is used for the correction of discrepancies and defects. A great number of workers from all plant departments are involved in the process of identifying the causes of the problems and proposing effective corrective measures. The number of safety relevant events has decreased already for several consecutive years.

In the Dukovany NPP as well as in the Temelín NPP a system of WANO safety indicators evaluation is implemented, continuously providing information about the standards in the monitored areas in other NPPs in the world. Gathered information is used to recognize own level of the Dukovany NPP and the Temelín NPP in the individual indicators of the safety and operational status. SÚJB uses the set of safety indicators to assess the nuclear safety level. The results of the safety indicators for 2001 – 2006 and for Dukovany NPP as well as Temelín NPP are shown in Annex 6.

Causes for repeatedly occurring events are evaluated on a regular basis. In events discussed by the commission for the investigation of events (safety relevant) no repeatedly occurring events were identified. Repeated events (problems) monitored in the category of small events (without a direct impact on nuclear safety) are also regularly evaluated in the annual report and their elimination is continuously monitored and evaluated (see Chapter 14.1.6).

Corrective measures fulfillment success rate is also part of regular yearly evaluation of the feedback in the power plant. In the past period it was possible in most cases to fulfil the corrective measures and thus eliminate the causes of discrepancies in the scheduled dates.

Legislations related to the external feedback process were updated in accordance with the requirements resulting from the real assessment, evaluation, and external information utilization process. A new guideline of principles describing the contact of Dukovany NPP with the WANO organization was issued. Temelín NPP draws a lot of knowledge from the WANO sources and the power plant itself has started providing information to the WANO network since 2004.

Basic system standards establishing principles for safe and reliable operation control are the Operation Control and Procedures and the Production Equipment Operation and Monitoring.

The Operations Control Rules are formulated in accordance with the ČEZ, a. s. strategy so

that their observance shall ensure safe, reliable and economic and environmentally friendly operation of the nuclear installation, in compliance with:

- conditions of the SÚJB authorization;
- provisions of the binding legal decrees of the Czech Republic (acts and their implementing decrees);
- operating procedures.

Operation of the Dukovany NPP as well as of the Temelín NPP is managed by the Operations Control Department. The division of responsibilities for the individual activities is defined in the corresponding quality assurance programs.

Special emphasis is put on preparedness and qualification of operating personnel, especially so-called "selected personnel", i.e. personnel who have an immediate effect on nuclear safety (see chapter 6). Also other operating personnel undergo selection, training and hands-on training for the relevant function.

Shift operation in the Dukovany NPP as well as in the Temelín NPP is ensured by six, or seven (for selected professions), equally competent shifts providing for the operation as well as for periodic training and proper rest of the personnel.

Within all unit modes both NPPs use the PSA risk monitor application for monitoring the unit operation risk. Data about unavailability of equipment is analyzed for the reasons of tests, maintenance, and failures in all units. The analyses result in measures leading to the minimization of the operational risk.

When planning the equipment tests and maintenance, the outputs of the risk monitor are used to eliminate combinations of equipment unavailability, which are allowed by Limits and Conditions, but could increase the operational risk in the NPPs.

Organization and activities during annual outages

Preparation and progress of the outage in the Dukovany NPP or the Temelín NPP is controlled by a group of personnel nominated by the Coordination Department manager in the following composition:

- outage manager,
- primary circuit working group head,
- secondary circuit working group head,
- electro working group head,
- measurement and control working group head.

An Outage Team may be also appointed by the Power Plant Manager for the preparation and course of the outage. The representatives of the main departments of the power plant are appointed to the Outage Team.

Shift maintenance dispatcher, who controls and checks the work in accordance with the approved specification for afternoon and night shifts and for holidays, cooperates closely with this group of outage management. In the Temelín NPP the function of the shift maintenance dispatcher is carried out by the reactor unit manager.

Each working group meets on a regular basis on working days for consultation meetings, where its members inform on the current state of the monitored activities, and where tasks directed to the fulfillment of the plan of works are assigned.

After the consultation meetings, consultation meeting of the outage control group is held, at which, additionally to the heads of the working groups, the reactor unit manager, shift maintenance dispatcher and nuclear safety representative are present. During this meeting tasks for the next 24 (or for 72) hours are assigned. Orders for the shift personnel are also consulted here, which are concentrated into an official document, named Daily Operational Schedule, which is being issued daily.

Fulfillment of the assigned tasks is then checked and evaluated during the consultation meeting of the shift maintenance dispatcher in the presence of the outage manager, the heads of the working groups, coordination and representatives of the administration of property, which is held the following day at the beginning of the morning shift.

During the occurrence of non-standard states, which could jeopardize the scheduled progress of the outage, the outage manager calls together the Control Staff, which adopts, after having evaluated the event, measures for the correction of the state.

Preparation of the outage begins six months prior the scheduled date of its beginning, in accordance with the yearly outages scheduled. The yearly schedule is linked to the long-term plan of plant outages, where also the presumed duration of the outage is given based on the standard whilst taking into account long-term extensive activities.

- Basic framework of the main activities is determined based on regular periodic checks of the main components of the unit.
- Important scheduled reconstruction and modifications are included.
- Preparation of complex activities, such as special inspections, plant modifications, may be in progress even several years prior the corresponding outage.
- Six months prior to the corresponding outage, fulfillment check of the conclusions and measures from the preceding outage is performed.
- Six months prior to the outage, regular Coordination Consultation meetings are started.
- Requirements for execution are further detailed, simultaneously preparation of activities from the viewpoint of material assurance, documentation, selection of the contractor, approval by the regulatory body, etc. is in progress.
- Two months prior to the outage the Coordination Department issues the official schedule of the outage, created using the network planning method. The schedule includes decisive activities, which will be performed during the outage. The schedule includes revisions of the main components of the unit, important modifications of the equipment, order of the revisions of the individual electrical systems, availability of the safety systems and also includes logic links of the individual activities. The schedule includes already the sequence of important unit tests during the unit start-up. In the schedule the so-called critical path of the outage activities is marked. The outage schedule is assessed, from the viewpoint of reactor core damage risk, using the probabilistic calculation and it is optimized for the decrease of risk to be as low as achievable.
- Two months prior to the outage, preparation of the work orders for scheduled outage activities is finished and work starts on grouping these orders into the securing ones and the safety related ones.
- One month prior the outage, a list of modifications and technical solutions, which will be carried out during the outage, is submitted to the SÚJB.

- One week prior the outage a document is issued (operative program), describing in detail activities, which will be carried out in the frame of the unit outage. The document includes also the time schedule. A similar document is elaborated also for activities during the unit start-up after the outage.
- Approximately two days prior the reactor start-up an expert commission meets (Technical Committee) to judge, based on a report on the performed operational checks, whether the reactor and the pertinent equipment is ready for the restart.
- Subsequently an application for the authorization of the reactor restart is sent to the regulatory body (SÚJB).
- Within one month after putting the reactor into operation a report on the performed repairs on the classified equipment is submitted to SÚJB.
- Within two months after the outage, a summary report on the outage including recommendations and measures for later outages is elaborated.

The outage structure is governed by the following philosophy:

- One critical path is clearly defined.
- During the outage systems and components will be put out of operation and locked once only.
- During the outage the Shutdown PSA (core damage frequency) recommendations are taken into account.
- Systems and components with finished maintenance are tested in accordance with the approved procedure. These tests are performed by the Operations Control Department prior to placing them into normal operation.
- Progress of works being in the critical path and in its vicinity is monitored in detail.
- Information on the overall progress of the outage belongs to the information frame being daily submitted to the outage coordination group.

Maintenance

The mission of the maintenance in the Dukovany NPP as well as in the Temelín NPP is to provide and controls all activities on plant equipment so that they are:

- in accordance with the plant design,
- in accordance with the Czech Republic legislation,
- in accordance with international recommendations,
- in accordance with the internal control documents,

and the following is assured:

- nuclear, radiation and conventional safety,
- required reliability,
- design lifetime,
- Limits and Conditions for safe operation,

and this is done with respect to optimal and effective spending of financial resources.

The main goal of maintenance is to ensure the required availability of the nuclear power plant technological equipment, timely removal of defects, their documenting and performance of monitoring.

The equipment maintenance is carried out in accordance with the elaborated maintenance program for individual equipment including also the preventive maintenance program. The maintenance method and scope depend on the required safety and reliability of the equipment.

The maintenance on equipment of all units in both NPPs is planned materially and financially for a long-term period (5 years), and daily (daily maintenance plan). The maintenance is primarily ensured on a supply basis.

Inspections and tests

During the operation of the units and during regular refueling outages, the Dukovany NPP and Temelín NPP operating personnel perform regular tests of the equipment. Extent of the tests and their periodicity is given by the Limits and Conditions for safe operation and the Operating Procedures. Based on the requirements given by these documents annual time schedules of the tests are elaborated. For each test methods procedures are prepared, upon which the operating personnel act during the test. According to the test character, these tests are carried out either by qualified plant personnel or by qualified personnel of a supplier in cooperation with the corresponding experts from the plant. Each performed test is documented by a protocol or record.

Possibly identified deficiencies are eliminated, depending on their character and significance, in accordance with a system, described in the internal decrees of the plant. Those are formulated so that the requirements of the Limits and Conditions for safe operation and/or Operating Procedures are always fulfilled. Observance of the deadlines, actual performance and evaluation of the tests is controlled by independent control workers and by responsible managers.

Independent monitoring and evaluation of tests and inspections

Fulfillment and observance of requirements prescribed in the document Limits and Conditions approved by SÚJB has in the Temelín NPP one of the highest priorities when assuring safe operation and is also the precondition for the fulfillment of safety analyses prerequisites. Limits and Conditions define the conditions for the operation of the unit, under which safety of the operation is proven. In the Temelín NPP systems are established for performance of checks in accordance with the Limits and Conditions, as well as for independent monitoring and evaluation of the correctness, effectiveness, and completeness of other documents and activities, susceptible to influence the fulfillment of the Limits and Conditions.

Requirement for the performance of internal independent checks of the limits and conditions observance is anchored in the Limits and Conditions document. Performance of equipment checks beyond the scope of requirements for inspection resulting from the Limits and Conditions is described in the Operating Procedures. These inspections are carried out by the guarantee for individual systems and all responsible plant departments are acquainted with their results by protocol.

14.1.4 Intervention procedures for the anticipated operational events and accidents

Procedures for activities carried out by the shift personnel and the unit main control room personnel are established in the Operating Procedures. All NPP operating documentation underwent an extensive reworking. Operating Procedures are divided into two parts: operating parts - used by operators in the process control, and descriptive part - used principally for the training purposes which, besides a detailed description of the equipment, contain description of the operating states, design values and other necessary data. All new documents are

formally unified for both NPPs. Databases of signals, protections and blocks, valves, drives, etc. are being loaded in accordance with the documents revision. A new system of the databases provides for a better updating of the documents and is an important initial step for the preparation of the nuclear power plant's extensive modernization.

For cases of abnormal status occurrence the relevant procedures (AOP) are elaborated in both NPPs.

For the support of the MCR operational personnel during the control of situations under emergency conditions, symptom-based Emergency Operating Procedures (EOPs) were prepared. Either the reactor scram or start of the safety systems is an initiation event for the start of the activities in accordance with the Emergency Operating Procedures.

These symptom-based Emergency Operating Procedures were evaluated in accordance with the methodology and in cooperation with the Westinghouse Company.

The package of the strategies includes a wide range of events within the emergency conditions – ranging from design basis accidents to possible combinations of events, including multiple breaks and equipment failures. Emergency Procedures include in accordance with the PSA Level 1 study, all relevant scenarios, which might lead, with a certain probability, to the core damage. The MCR operative personnel interventions are always in accordance with the requirements for the minimization of consequences of a possible radioactivity release into the environment.

The Emergency Operating Procedures deal with emergency conditions of the NPP according to their symptoms, i.e. independently on events. Monitoring of the critical safety functions is an integral part of the procedures. All emergency states are always resolved till the so-called safe condition, when a nuclear unit is fully under the operator's control, and is mostly cooled down to the primary circuit temperature less than 100°C in accordance with the Operating Procedure.

The Procedure was developed by experts with many years of operating practice. Individual stages of the new operational Procedure development were subjected to verification by both Westinghouse and units main control rooms personnel. A study of the human factor response in the application of the Procedure has been performed. The emergency procedures were validated on the simulator. Use of the procedures for abnormal and emergency conditions is regularly trained on the full-scale simulator.

The Emergency Operating Procedures (EOPs) are currently updated on regular basis using changes in design, comments arising during simulator training and especially comments arising from the long-term Westinghouse contract (the so-called "Maintenance program"). Annual meetings of the Procedure authors and Westinghouse employees are held to discuss significant comments and proposals from the NPP side and, at the same time, the Westinghouse Company discusses with the NPP personnel approved changes in generic instructions. Approved changes are after validation included into the Emergency Procedures. Extensive causative documentation, the so-called "Basis", forms an integral part of the Emergency Procedures.

The Emergency Procedures are also accompanied with a list of the reference analyses, which served as an input for the development of the Procedure and a list of analyses, which were used for the procedures validation, including their changes.

The procedure for fault condition solutions (Shutdown EOPs) was created for non-power

reactor modes. The PSA results for non-power conditions (Shutdown PSA) were used as background material for the creation of this Procedure. The Procedure amends the EOPs so that all operating modes, including outage and refueling are covered.

In cooperation with the Westinghouse Company guidelines were created for the NPPs for the resolution of severe accidents (Severe Accident Management Guidelines - SAMGs). The guidelines are linked to EOPs. The guidelines are created both for the support of main control room personnel activities and (in particular) for the support during decision-making process of the Technical Support Center (TPS) and the Emergency Headquarters (HŠ). Use of SAMGs, contained strategies and phenomena in severe accidents are the subject of the training of expert personnel of the main control room (BD), the Technical Support Center (TPS) and the Emergency Headquarters (HŠ), and are practiced during emergency exercises.

All above given procedures (AOPs, EOPs, Shutdown EOPs and SAMGs) are created in the framework of one philosophy. The procedures are described in the same form and provide for defense-in-depth in the second through fourth level in accordance with the INSAG 10 document issued by the IAEA.

14.1.5 Engineering and technical support

Within the ČEZ, a. s. Engineering department organizational structure, the Technical Development and Design Administration section is integrated, which performs and coordinates the activities of the engineering and technical support. This section has a common competence for both Czech nuclear power plants. Section responsibility and rights are clearly established in the ČEZ, a. s. control documents.

Main objectives of this section in the field of design administration are as follows:

- control of the Design Basis collection and update process and its utilization in the performance of equipment configuration changes (Design Basis),
- update of selected License Basis documents,
- equipment qualification process control,
- preparation of long-term operation of the Dukovany NPP and Temelín NPP beyond the design lifetime (PLEX/LTO),
- assurance of technical part as to nuclear-power installation decommissioning,
- utilization of national as well as international technical supporting programs.

Main objectives of this section in the field of equipment configuration changes control are as follows:

1. In the phase of pre-designing stage:
 - Acceptance and assessment of requirements (Technical Initiations) of the equipment administration departments, operational departments and other departments of both NPPs for the equipment configuration changes.
 - Elaboration of conceptual design assignment for given required and relevant changes in the equipment configuration (Technical Assignment).
 - Complex assessment of technical, operational and safety aspects of prepared change in the equipment configuration, including fulfillment of legislative requirements to the state authorities.
2. In the phase of design preparation and implementation:

- Check of design documentation of the equipment configuration changes from the viewpoint of observance of a conceptual technical assignment, which placed this change into the designing stage.
- Technical support during implementation (installation) of the equipment configuration changes and during verification and testing of modified design functions affected by these changes (PKV).

Elaboration of technical part of evaluation of implemented equipment configuration changes (final modification evaluation).

Performance of technical and engineering support is controlled by the advisory body of the ČEZ, a. s. - Technical Committee.

Within the Engineering department the Preparation and Implementation Investment section is integrated, which ensures technical and commercial preparation of the designs as well as implementation of the equipment or system modifications, so that the equipment administration departments, or the operational departments are entrusted with the charge of modified and tested equipment through the "turnkey" system, including delivery of required documentation. The TRASP a PARI Department cooperate even in evaluating technical and economic benefit of each modification of the equipment and system.

Technical and engineering support is provided by highly educated personnel, qualified for specific tasks they perform themselves, or which are performed under their supervision. Close working relationships exist between the departments TRASP a PARI and the operational departments of both NPPs, which are again formally defined in the ČEZ, a. s. control documents. When performing the technical and engineering support the ČEZ, a. s. closely cooperates with the general designer of both Czech nuclear power plants, the ÚJV a. s. - EGP Praha Division, as well as with the Russian design organizations, which are authors of the original type designs of the VVER nuclear units. Further cooperation is continuously in progress with qualified research and scientific organizations and universities, as well as with suppliers and designers of implementing designs of individual systems of nuclear units of both plants.

Restoration together with upgrading of safety systems, I&C system and the unit information system in the Dukovany NPP is provided within the organizational structure of the ČEZ, a. s. Engineering department by the I&C system Renovation section in the Dukovany NPP, which controls this extensive action. The section provides and controls all technical and investment activities related to this action, while closely cooperating in the technical field with TRAPS department.

14.1.6 Operational events experience exploiting in ČEZ, a. s. NPPs

The ČEZ, a. s. nuclear power plants apply the system permitting to benefit from their own operating experience – the Dukovany NPP since the beginning of its commercial operation in 1985, and the Temelín NPP in the course of its constructions and commissioning. At the same time also experience from international nuclear power plants, obtained from the WANO network and from operators in Slovakia, is used in the NPP. The whole process, which includes examination of the operational event causes, remedial measures and feedback of experience from these events, is ensured by specific departments in the relevant NPP and is described in relevant control documentation in individual NPPs.

The process covers methods for gathering information on operational events, their registration, investigation procedure, and analysis of their causes, establishment and adoption of remedial measures for these events, monitoring of their implementation and evaluation of operational events feedback effectiveness and trends. The process also includes obligation and procedure for the transfer of own experience to other NPP operators and for the dissemination of foreign and own operational experience within the plant.

In the given documentation, criteria are also given for recording the events; for safety related events the documentation also provides criteria in accordance with which selected events are reported to the SÚJB or other relevant bodies or organizations (ČEZ, a. s. Headquarters, Hygiene Service, Fire Service, etc.).

The events are evaluated according to the INES international scale for evaluation of event significance in the nuclear installations. A head of the Nuclear Safety section is responsible for the event-related investigation. This section coordinates the whole process of events investigation in the power plant, but also other further plant specialists from special departments are involved in the process.

Part of the above activities is supporting personnel honesty and effort to consistently investigate all events, which may jeopardize safe and reliable operation. The principle is that open communication setting and the admission of own mistakes is an acceptable impetus to improvement of the safety culture, whilst the priority is not to find the guilty parties, but to improve the condition.

For regular evaluation of effectiveness of experience from own operational events, the main criterion is the event non-recurrence for the same causes. Repeated events or problems are regularly evaluated in the ČEZ, a. s. NPPs in annual reports on the operational events and possible further measures are proposed. For tracking problematic areas – trends, precursors – the coding of events causes is used. This is elaborated once per two years as Annex to the annual report "Feedback from internal events".

Three types of events are distinguished in the monitoring system (process):

- 1) Events important from the nuclear safety viewpoint. These events must be discussed by the Failure Commission of the relevant NPP and the causes together with the adopted corrective measures are regularly checked out by the SÚJB.
- 2) Minor (less significant) events (INES classification always less than 0, they are classified out of scale). These events are investigated within the work order of the corresponding departments; these events are not discussed by the Failure Commission; corrective measures are checked by the feedback of working group and approved by the Failure Commission.
- 3) Events without consequences ("near misses"). These events are treated in the same way as the events in the preceding paragraph. Their possible influence on any process in the plant is being evaluated.

The Events Investigation Commission (Failure Commission), which is established as the advisory team of the executive director of NPP for identification of causes, corrective measures and conclusions for the events investigation in individual power plants, confirms at its regular meetings the completeness of the investigations of safety related events causes and adopts corrective measures for the elimination of their causes for the purpose of prevention of their repeating.

Significant events are also discussed by Technical and Safety Commission in the presence of the plant top management. The corrective measures are filed in a special program, and their state and method of their fulfillment is regularly checked.

NPPs dispose of the relevant, which allows recording and processing of characteristic data of that event resulting after completion of the process of investigation. This makes all important data and experience available to other NPP personnel to be used for the improvement of the plant operation reliability. The power plant personnel is informed on selected events both from internal and from external feedback.

In accordance with the law, SÚJB supervises this process, and in some cases of important events, inspects the progress of examination and assessment of sufficiency of remedial measures taken in the course of event management.

External events

ČEZ, a. s. NPPs are actively involved in the international organization of nuclear power plant operators. This allows active and effective mutual cooperation with other NPP operators in operational experience exchange. Analysis and utilization of operational experience and technical information from other operated nuclear power plants conduce to improvement of the NPP operation safety and reliability. When sharing own operational experience the ČEZ, a. s. NPPs conduce to effective application of this process within the international context.

The above given system of taking profit from the events in other nuclear installations on worldwide basis is incorporated into the event investigation process. The main objective of the system is to transfer and to utilize any operating experience and technical information acquired by nuclear power plant operators in the ČEZ, a. s. NPPs practice. The system is described in a special instruction and comprises five basic programs:

- operational events reports,
- direct information exchange between the operators,
- operational indicators WANO, PRIS,
- good practice,
- partner inspections.

Information selected from WANO, INPO, IAEA and NEA sources is included into agenda of the Events Investigation Committee. All obtained information is archived in form of a database, and used by the plant experts as technical support in resolving plant's problems.

14.1.7 Notification of events important for nuclear safety

One of the basic legal obligations of the nuclear installation operator is to immediately notify safety related events to the Regulatory Body. Transferred reports cover the solution of events and non-nominal states, in relation to nuclear safety, radiation and physical protection, emergency preparedness and nuclear materials management, as well as all other activities and changes affecting nuclear safety and radiation protection.

Extent and methods for transfer of information on selected events in respect of nuclear power plants operational safety, are established by the common Agreement between ČEZ, a. s. and SÚJB. The reporting procedures are described in the plant internal documents. The Regulatory Body is regularly informed on the operational state of all reactor units through a daily report, which is always mutually consulted and amended by verbal commentary on other current

information from the morning operative session of the shift engineer. The inspectors are acquainted with other scheduled activities for the nearest period through a valid daily operation plan.

For the operative communication (provable immediate transfer of information) both NPPs established a special log of operative contact between the operator and local safety inspectors.

14.1.8 Optimization of nuclear installation operational radioactive waste production

Basic objective

Radioactive wastes from normal operation of both NPPs, with exception of highly active wastes (components of reactor internals), are stored, after the appropriate treatment, within the Dukovany Radioactive Waste Storage Facility. With respect to ecological and economic conditions of the NPPs, radioactive waste storage in this storage facility represents an optimal option fulfilling the basic objective – its isolation from the environment, until its radioactivity is significantly reduced as a result of decay. Storage in the storage facility is conditioned by processing the radioactive wastes into a form suitable for storage.

Liquid radioactive wastes are temporarily stored as radioactive concentrate after sedimentation and concentrating. Subsequently, they are processed in a bitumen product. Operation of the bitumenation line is organized so that the permitted volume of stored concentrates is not exceeded, and at the same time there is sufficient free volume for sewerage waters from the units operation. In the Temelín NPP this means processing of the whole volume of sewerage waters in several campaigns in the course of the year. In the Dukovany NPP the capacity of the technological equipment allows processing of concentrates with the volume higher than the volumes of new sewerage waters, and thus the quantity of stored concentrates permanently decreases.

Solid radioactive wastes are systematically sorted and measured. Part of the waste, which fulfils the strict criteria of release level, is released, under strict control, into the environment. Remaining wastes are processed and stored. For the final treatment of compressible wastes the high-pressure compressing is to be used. The waste to be combusted outside the Czech Republic is currently being prepared.

Radioactive sediments and adulterated sorbents are stored in the storage tanks. Currently the verification of technologies for treatment of these wastes is in progress.

Minimization principle

The basic requirement during radioactive waste management is the minimization of their amount. This process includes avoidance of the waste occurrence, modification of technological equipment, operating procedure modifications and optimization of processes during the waste treatment and processing. Minimization is understood as a complex process with direct impacts both in environmental and economic indicators of the NPP operator.

At NPP, the following measures are continuously implemented aimed at reducing the radioactive waste generation:

- development and implementation of low-waste decontamination technologies,
- separation of non-active sediments from the exchanger cleaning,
- restriction of objects brought into the controlled area and unrelated to working activity,
- limiting entries of persons into the controlled area,

- optimization of protective plastic sheets usage,
- replacement of service water with condensate or demineralized water in points, where leakage occur (reduction of salts amount in radioactive concentrates).

14.2 Statement on the implementation of the obligations concerning Article 19 of the Convention

The above text proves that the legislative requirements imposed on the commissioning of a nuclear installation, its operation and performance of the proper activities are conform, in the Czech Republic, to the requirements of Article 19 of the Convention.

ANNEXES

to the National Report of the Czech Republic under the Convention on Nuclear Safety

**ANNEX 1 Description of the Dukovany and Temelín NPPs,
and listing of the performed safety improvements**

ANNEX 2 IAEA safety recommendations fulfillment status

ANNEX 3 IAEA and WANO Missions

ANNEX 4 The Morava Equipment Renovation Program

**ANNEX 5 List of Legislative Regulations Dealing with Nuclear
Energy and Ionizing Radiation and Related Documents**

ANNEX 6 Evaluation of the Safety Performance Indicators Set

ANNEX 7 References

ANNEX 8 Research Nuclear Installations

ANNEX 1 Description of the Dukovany and Temelín NPPs, and listing of the performed safety improvements

1. Dukovany NPP

1.1 Main components

PRIMARY CIRCUIT

1. Reactor
2. Steam generator
3. Pressurizer
4. Spent-fuel storage pool
5. Refueling cavity
6. Fuel charging machine
7. Main coolant pump
8. Bubbler tower
9. HVAC system
10. Ventilation stack
11. Reactor building crane

SECONDARY CIRCUIT

12. Turbine high pressure stage
13. Turbine low pressure stage
14. Generator
15. Condenser
16. Separator-reheater
17. Regenerative heaters
18. Feedwater tank with feedwater deaerator
19. Steam piping into turbine
20. Cooling circulation circuit piping
21. Insulated cables for generator power outlet
22. High-voltage transformer of power output 400 kV
23. House transformer 6 kV
24. Manipulation crane

1.2 NPP technical parameters

Number of units	4
Reactor type	PWR VVER 440/213

Output parameters of one unit

Nominal thermal output	1375 MWt
Generator output	440 MWe
Net electrical output	388 MWe
Auxiliary consumption	52 MWe

Main coolant pump

Number per unit	6
Nominal power consumption	1.6 MW
Operational capacity	approx. 7000 m ³ per hour
Rotor speed	1460 r.p.m.
Pump weight	approx. 48 t

Reactor technical parameters

Reactor height	23.67 m
Pressure vessel inner diameter	3.542 m
Cylindrical part wall thickness	340 mm
Thickness of pressure vessel cladding	9 mm
Empty pressure vessel weight	215.15 t
Reactor weight	395 t

Turbine

Number of high pressure sections	1
Number of low pressure sections	2
Nominal rotor speed	3000 r.p.m.
Inlet steam temperature	256°C
Inlet steam pressure	4.3 MPa

Reactor core

Number of fuel assemblies	312
Number of fuel rods per assembly	126
Number of control assemblies	37
Core height	2.5 m
Core diameter	2.88 m
Fuel enrichment	3.82*/4.25**/4.38**% U 235
Core loading (UO ₂)	42 t
Fuel cycle	five years

Generator

Rated power	220 MW
Output voltage	15.75 kV
Nominal frequency	50 Hz
Cooling media	hydrogen - water

* with profiled enrichment
** with profiled enrichment and burnable absorber

Condenser

Number per turbine	1
Number of pipes per condenser	31 716
Water flow	35 000 m ³ per hour
Pipe material	titanium

Reactor cooling system

Number of cooling loops	6
Inner diameter of main cooling piping	500 mm
Volume of coolant in primary circuit	209 m ³
Primary circuit working pressure	12.25 MPa
Inlet coolant temperature	approx. 267 °C
Outlet coolant temperature	approx. 297 °C
Reactor coolant flow	42 000 m ³ per hour

Cooling towers

Number per unit	2
Height	125 m
Diameter in top of the tower	59.49 m
Foot diameter	87.94 m
Wall thickness	0.6-0.15 m
Water flow (one tower)	approx. 10.55 m ³ per second
Volume of evaporated steam from one tower	max. 0.15 m ³ per second

Steam generator

Number per unit	6
Steam production per SG	452 t. p h.
Steam output pressure	4.61 MPa
Steam output temperature	260.0 °C
Steam generator weight	approx. 165 t
Steam generator body diameter	3.21 m
Steam generator body length	11.80 m

1.3 Modernization changes already implemented in Dukovany NPP

A) Changes implemented within the “Back-fitting of Dukovany NPP”

1. A7 Main coolant pump control algorithms modification
2. A8 Steam generator level measurement reliability improvement
3. A12 Hydrogen recombination system within hermetic zone installation
4. A21 High-pressure compressors replacement
5. A23 Addition of redundant back-up to the category one power supplies No. 4
6. A30 Teledosimetric system installation
7. A32 Grab tank on Skryje stream installation
8. B1 Cooling system installation for the machine halls roof steel structure
9. B5 Stationary fire extinguishing equipment installation for central oil system
10. B7 Unit electrical fire detection system upgrade
11. B10 Stationary halon fire extinguishing system installation for unit electrical equipment

B) Changes implemented within the “Modernization of Dukovany NPP”

1. ZL 1702 Installation of electrical fire detection system at water pump station “Jihlava”
2. ZL 2180 Modernization of system for public warning during accidents
3. ZL 2374 Construction of interim spent fuel storage facility
4. ZL 3103 0.4 kV switchgears upgrade
5. ZL 3582 Hydroaccumulators isolation valves control
6. ZL 3664 32/16/16 MVA back-up house transformer installation
7. ZL 3701 Pressure measurement in the SG box
8. ZL 3704 Reconstruction of the protection actuated by “MSH break” signal.
9. ZL 3818 EDU surroundings teledosimetric system - RA control data transfer
10. ZL 3863 Fire-proof spraying of critical and important cable rooms
11. ZL 4290 Pressurizer safety valve’s keys modification
12. P588 Innovation of boronmeters
13. P590 AKOBOJE (nuclear power plant automatic security guard complex) optimization
14. P591 Replacement of Freon in cold supply plant
15. P598 Water treatment station modernization
16. P601 Conversion of documentation to the digital form
17. P602 MCR full scope simulator
18. P606 Roof flats construction for the EDU employees
19. S150 Condenser reconstruction
20. S357 Post-emergency hydrogen recombination
21. S439 Replacement feeding water line for the I&C sensors flushing system
22. S568 Spray system’s sumps protection
23. S675 Replacement of water and oil coolers in the diesel generator I station
24. S765 Condensate treatment system modernization
25. S776 Diesel generators electrical system reconstruction
26. S907 Extension of stable sprinkling device functions
27. S952 Construction of intermediate floor in the panel intermediated relay’s rooms and common control rooms
28. T130 Construction of new telephone switchboard

29. T215 The Jihlava Pumping Station I&C reconstruction
30. T248 Pressurizer safety valve (relief valve) node reconstruction
31. T263 Auxiliary feedwater pump replacement
32. T317 Replacement of water and oil coolers for diesel generator II station
33. T370 Replacement of storage pool pumps by a sealess type
34. T516 Fitting of diodes in I&C switchboards
35. T547 Batteries replacement in First category power supplies system No. 4
36. T556 Control room diesel generator annunciation upgrade
37. T703 Ultimate emergency feedwater pump to SG section collector displacement
38. T764 Secondary circuit continuous measurement system installation
39. T785 Intermediate building +14,7 pipeline whip restraints
40. T802 Section switchboards service inlets of selected consumers reconstruction
41. T982 Fire protection barriers
42. T983 Fire protection barriers
43. T984 Fire protection barriers
44. T996 Access path to cooling towers
45. U064 Coating of the twin unit II, primary part of 3rd and 4th reactor unit
46. U097 Chemical plant continuous measurement
47. U116 Bringing out of „Danger of SG overpressurising“ signal
48. U247 Coating of cable rooms in transversal and intermediate building and turbine hall – reactor unit No.1
49. U444 Outside transformer basements
50. U496 Exhausting of storage pool
51. U560 Reconstruction of drinking and fire water in Dukovany NPP, stage II
52. U584 Emergency lightning of chemical neutralization building
53. U685 Revitalization of AKOBOJE (nuclear power plant automatic security guard complex) and arrangement of Back-up control centre
54. U697 Emergency venting of primary circuit
55. U725 Covering of rail access corridor of twin units I, II
56. U726 Replacement of pressure measurement recording devices
57. U754 Protection of DIAMO K input signals
58. U775 Elimination of the scram protection signal – the pressure in the main steam collector
59. U777 Assuring of the NPP Dukovany tertiary regulation
60. U780 Assuring of the NPP Dukovany secondary regulation - reactor unit 1 and 2
61. U876 Upgrade of the SCORPIO-VVER system
62. U917 Modification of the DukNet computer network
63. U919 Modification of the turbogenerator drip tank
64. U950 Modification of internal connecting pipelines of auxiliary service buildings for primary systems
65. U969 Checking of bitumenation in the low-level waste treatment
66. V015 Reconstruction of the air conditioning P – 460, 461, P – 470 in the operational building II.
67. P059 Reconstruction of de-mineralized water pipelines including fittings
68. V061 Modification of SW extractor data from central information system of radiation control for emergency coordination centre of Regulatory body
69. V062 Modernization of Monitoring system electric – binary part
70. V063 Modernization of Monitoring system electric – analog part
71. V064 Modernization of Monitoring system electric – central unit

72. V066 Superstructure of diagnostic systems for free parts monitoring
73. V077 Modification of information system LOIS
74. V078 Upgrade of the Genie Inspector software
75. V082 Modification of the DARS system
76. V103 Separation of turbine-generator intermediate circuits
77. ST152343 Heating steam inlet regulation for condenser-deaerator
78. ST153272 Elimination of electronic fire alarms false signals
79. ST153589 Feeding water and steam balance disturbance signaling
80. ST153919 Construction of the waste management center near by the auxiliary boiler plant
81. ST154113 Auxiliary power supply for the 9CN201 switchboard
82. ST154119 Effluent measurement in the VK1 ventilation stack
83. ST154173 Signaling of flooding of underground areas in turbine hall
84. ST154782 Completion of eyes' rinsing devices in auxiliary service buildings for primary systems
85. ST154897 Installation nets for windows in the turbine hall
86. ST155021 Cooling of panel intermediated relay-2 and panel intermediated relay-3 in 3rd reactor unit
87. ST155038 Assuring of the internal contamination measurement during loss of DukNet-Genie2000
88. ST155039 Exchange of comparative protection of the V483-6 line
89. ST155042 Virtual power plant
90. ST155054 Enlargement of the alpha server 3 RAM and HDD capacity
91. ST155055 Assuring of substitutional effluent measurement in Laboratory of radiation control of environment
92. ST155070 Modification of the ARS software (physical protection system)
93. ST155075 Upgrade of SCORPIO – VVER II
94. ST155099 Air elimination from the cold supply plant condenser
95. ST155100 Separation of turbine-generator intermediate circuits
96. ST155102 Information system security increasing in NPP Dukovany
97. ST155124 Replacement of the I&C equipment in the intermediate building +14.7 m - reactor unit 2
98. ST155189 Exchange of PC/reactor operator, PC/turbine operator, PC/SERVIS BLAN
99. ST155197 Installation and operation of "Photovoltaic power station" in NPP Dukovany
100. ST155198 Modification of Data terminal equipment and Secondary regulation promoter NPP Dukovany for tertiary regulation in remote control
101. ST155379 Application of DART in NPP Dukovany
102. ST15U875 Turbine hall equipment - pH increasing
103. ST155567 Installation of tilted rail
104. ST154561 Strengthening of high energy pipelines
105. ST153786 Motors drives of valves on 14,7 level of intermediate building
106. ST155213 Upgrade of N16 measurement
107. ST155108 Contamination measurement of subjects on Dukovany NPP area borders.
108. ST155184 Seismic strengthening of TS10,50W01,02
109. ST155300 Seismic strengthening of dieselgenerator station (DGS) 2 (units 3,4)
110. ST154482 Dieselgenerator (7-12) reconstruction
111. ST154440 Measurement of H₂ concentration in systems TS10, TS50
112. ST154635 Rupture protection of HNK (main feedwater header) and HVK (main

- discharge header) -mechanical part
113. ST155158 Seismic strengthening of DGS
 114. ST155171 Installation of identification card scanner in the entry to shelters
 115. ST154481 Dieselgenerator (1-6) reconstruction
 116. ST155367 Equipment qualification - seismic analyses, type tests
 117. ST155444 DG over-revolution protection algorithm modification
 118. ST155036 Installation of internal emergency siren at education and training centre
 119. ST154226 Replacement of fire-protection doors
 120. ST154685 Revitalization of AKOBOJE (nuclear power plant automatic security guard complex) and arrangement of Back-up control centre – creation of dislocation conditions
 121. ST154554 Detection system of leakage amount from primary circuit

2. Temelin NPP

2.1 Main components

1. Reactor
2. Pipelines of primary circuit
3. Main coolant pump
4. Pressurizer
5. Steam generator
6. Polar crane
7. Spent fuel pool
8. Refuelling machine
9. Hydroaccumulators
10. Containment
11. Ventilation stack
12. Emergency core cooling system
13. Diesel generator station
14. Turbine hall
15. Feedwater tank
16. Main steam piping
17. High pressure turbine stage
18. Low pressure turbine stage
19. Generator
20. Exciter
21. Separator
22. Condenser
23. Heat exchanger
24. Coolant inlet and outlet
25. Pumping station
26. Cooling water pump
27. Cooling tower
28. Generator power output
29. Transformer
30. Power output
31. Distillate reservoirs

2.2 NPP technical parameters

Number of units	2
Reactor type	PWR VVER 1000

Unit parameters

Nominal thermal output	3000 MWt
Generator output	981 MWe
Net electrical output	912 MWe
Auxiliary consumption	69 MWe

Reactor technical parameters

Reactor height	10.9 m
Pressure vessel inner diameter	4.5 m
Cylindrical part wall thickness	193 mm
Thickness of pressure vessel cladding	7 – 18 mm
Reactor weight without coolant	approx. 800 t
Pressure vessel weight	322 t

Reactor core

Number of fuel assemblies	163
Number of fuel rods per assembly	312
Number of rod cluster control assemblies	61
Height of active core	3.6 m
Core height	3.1 m
Fuel enrichment	max. 5 % U 235
Core loading (UO ₂)	92 t
Fuel cycle	four years

Reactor cooling system

Number of cooling loops	4
Inner diameter of main cooling piping	850 mm
Volume of coolant in primary circuit	337 m ³
Primary circuit working pressure	15.7 MPa
Inlet coolant temperature	approx. 290 °C
Outlet coolant temperature	approx. 320 °C
Coolant flow	84 800 m ³ per hour

Steam generator

Number per unit	4
Steam quantity produced in 1 SG	1470 t/h
Outlet steam pressure	6.3 MPa
Outlet steam temperature	278.5 °C
Steam generator weight	approx. 416 t
Steam generator body diameter	4.2 m
Steam generator body length	14.5 m

Main coolant pump

Number per unit	4
Nominal power consumption	5.1 – 6.8 MW
Operational capacity	approx. 21 200 m ³ p. hour
Rotor speed	1000 r.p.m.
Pump weight	approx. 156 t

Containment system

Height of cylindrical part	38 m
Inner diameter of cylindrical part	45 m
Wall thickness	1.2 m
Thickness of stainless steel liner	8 mm

Turbine

Number of high pressure stage	1
Number of low pressure stage	3
Rotor speed	3000 r.p.m.
High pressure stage weight	206 t
Low pressure stage weight	480 t

Generator

Rated apparent power	1111 MVA
Power factor	0,9
Output voltage	24 kV
Nominal frequency	50 Hz
Cooling media	hydrogen – water
Weight	564 t

Condenser

Number per turbine	3
Number of pipes per condenser	approx. 32 000
Pipe length	12 m
Pipe material	titanium

Cooling tower

Number per unit	2
Height	154.8 m
Diameter in top of the tower	82.6 m
Foot diameter	130.7 m
Wall thickness	0.9 – 0.18 m
Number of askew columns	112
Water flow (one tower)	approx. 17.2 m ³ /s
Volume of evaporated steam from one tower	max. 0.4 m ³ /s

2.3 Modernization changes already implemented in Temelin NPP

1. I&C Systems replacement
2. Nuclear fuel, control clusters (lifetime)
3. Radiation monitoring system (RMS)
4. Primary circuit diagnostic system (TMDS)
5. Sipping
6. Bitumination system
7. Refueling machine I&C system replacement
8. Installation of compact grid in the spent fuel pool
9. Full scope simulator
10. Technical support center
11. Inverters, rectifiers (AEG)
12. Penetrations (Škoda + ISTC Company)
13. Replacement of J2UX circuit breakers
14. Unit transformer penetrations (Passoni Villa bushings)
15. Addition of back-up power supply for reactor building No. 2
16. Addition of a common back-up diesel generator station (DGS)
17. Increase of accumulator batteries capacity
18. Implementation of "reserve electrical protections" and provision for full selectivity in 6 kV radial electrical networks
19. Pressurizer electrical heaters continuous control
20. Installation of hydrogen recombination system
21. Post-accident hydrogen monitoring system
22. Replacement of selected valves
23. Reconstruction of stabile fire extinguishing system for outdoor power transformers
24. Introduction of secondary load follow regulation
25. Construction of plant terminal (TELETE)
26. Modification of the essential service water and non-essential service water systems
27. Replacement of pumps
28. Modification of containment cesspool system
29. Containment venting (single failure)
30. Titanium condenser pipes installation
31. RCCA drives replacement
32. Introduction of new chemistry control
33. New safety analysis
34. ATWS analyses
35. PSA level 1 and 2 development project
36. Severe accidents analysis
37. SW independent verification & validation project (IV&V)
38. Leak Before Break
39. EOPs development project
40. SAMG development project
41. Fire safety, cables, electronic fire detection system
42. Seismic analyses

43. Completion of documentation
44. ISE project
45. Modification of SG inner parts
46. Addition of new SG water level measurement
47. I&C system for polar crane replacement
48. Filtration system for emergency control room
49. Modification of main control room venting system
50. Installation of GERB absorbers
51. Addition of drench fire extinguishing system for main coolant pumps
52. Addition of radioactive waste treatment system for liquid wastes liquidation after accidents
53. Addition of system for collection of boric water and system for separation
54. Replacement of asbestos sealing
55. Installation of new heat-exchangers of active engineered safety systems
56. Addition of relief valve to pressurizer system
57. Replacement of steam generator steam pipes quick-acting valves
58. Modernization of main coolant pumps
59. Organized depository of high activity wastes
60. Replacement of Freon in cooling systems
61. Nuclear safety improvement (high energy piping separation)
62. Unit fire safety improvement
63. Nuclear safety improvement - improvement of steam generator safety relief valves functionality
64. Nuclear safety improvement - improvement of steam dump to atmosphere functionality
65. Essential and non-essential cooling water lines redesign
66. Steam generator steam flow measurement method improved
67. 1000 MW turbine high pressure control valves redesign
68. Condensate pumps improvement
69. Diesel generator electrical protection system modernization
70. Main divisional category II 6 kV switchboard (and selected non-unit 6 kV switchboard) emergency arc protection replacement
71. Electrical inverter (UPS for all the safety system motory loads) replacement.
72. Radiation safety information system
73. Turbine trip logic improvement
74. 10220 Modernization of NPP Temelin seismic network including supplement of seismic station
75. 10242 Algorithm for overwriting fixed pressure value in main steam header if Reactor scram or Limitation System take effect and SG level is below 185 cm
76. 10809 Function of subcooling and fixed T hot – elimination of inconsistency between RCLS and PRPS
77. 10846 Reconstruction of facility for liquidation of MNT and TK sensors
78. 10131 Exchange of valve motors in system TX for normal make-up
79. 10299 Design and documentation for exchange of existing nickel sealing of filter covers 1 (2) TC 10, 20, 30, 40 NO 1 by ridge-shape sealing
80. 10072 Replacement of existing Russian electromotor 4A315S6A5U3 cooled by water by motor with air cooling

81. 10776 Cooling Spent fuel pool within nominal unit mode after Fast acting valves on TG lines lockup.
82. 10798 Modification of introduction of impulse lines of pipelines, venting, and drainage lines from main technological line systems 1/(2) TO, 1/(2) TC, 1(2) TK, 1 TG, 2 YD
83. 10832 Exchange of pressuriser electroheaters sealing
84. 6739 Exchange of flesh protection
85. 6784 DGS protection modification
86. 7118 Exchange nickel and asbestos-graphitic packing of manhole pressurizer for ridge-shape sealing.
87. 7119 Exchange of existing nickel packing of primary collectors, secondary lids and side opening.
88. 10193 Supplement of nitrogen to thermosifons of Sulzer SO 800/04 pumps
89. 7064 Noise decrease in room No AE 340/3

ANNEX 2 IAEA safety recommendations fulfillment status

Safety issues solution status for the NPPs with VVER-440/213 at the Dukovany NPP

Ident.	Name of the safety findings	Cat.	State
G	GENERAL		
G 01	Classification of components	II	4
G 02	Qualification of equipment	III	3
G 03	Reliability analysis of safety class 1 and 2 systems	II	4
RC	CORE		
RC 01	Prevention of uncontrolled boron dilution	II	4
CI	COMPONENT INTEGRITY		
CI 01	RPV integrity	II	4
CI 02	Non-destructive testing	III	4
CI 03	Primary pipe whip restraints	II	3
CI 04	Steam generator collector integrity	II	4
CI 05	SG tubes integrity	II	4
CI 06	SG feedwater distribution pipe	I	4
S	SYSTEMS		
S 01	Primary circuit cold overpressure protection	II	4
S 02	Mitigation of a steam generator primary collector break	II	4
S 03	Reactor coolant pump seal cooling system	II	3
S 04	Pressurizer safety and relief valves qualification for water flow	II	4
S 05	ECCS sump screen blocking	III	4
S 06	ECCS suction line integrity	II	4
S 07	ECCS heat exchanger integrity	II	4
S 08	Power operated valves on the ECCS injection lines	I	4
S 09	Steam generator safety and relief valves qualification for water flow	II	4
S 10	Steam generator safety and relief valves performance at low pressure	II	3
S 11	Steam generator level control valves	I	4

Ident.	Name of the safety findings	Cat.	State
S 12	Emergency feedwater make-up procedures	I	4
S 13	Feedwater supply vulnerability	III	4
S 14	Main control room ventilation system	II	3
S 15	Hydrogen removal system	II	4
S 16	Primary circuit venting under accident conditions	II	4
S 17	Essential service water system	II	3
<i>I&C</i>	<i>I&C</i>		
I&C 01	I&C reliability	II	3
I&C 02	Safety system actuation design	I	4
I&C 03	Review of reactor scram initiating signals	II	4
I&C 04	Human engineering of control rooms	II	3
I&C 05	Physical and functional separation between the main and emergency control rooms	II	3
I&C 06	Condition monitoring for the mechanical equipment	I	4
I&C 07	Primary circuit diagnostic systems	II	4
I&C 08	Reactor vessel head leak monitoring system	II	4
I&C 09	Accident monitoring instrumentation	II	3
I&C 10	Technical support center	II	3
I&C 11	Water chemistry control and monitoring equipment (primary and secondary)	I	4
<i>EL</i>	<i>ELECTRIC POWER SUPPLY</i>		
EL 01	Start-up logic for the emergency diesels	I	4
EL 02	Diesel generators reliability	I	4
EL 03	Protection signals for emergency diesel generators	I	4
EL 04	On-site power supply for incident and accident management	II	4
EL 05	Emergency battery discharge time	II	4
<i>C</i>	<i>CONTAINMENT</i>		
C 01	Bubbler condenser strength behaviour at max. pressure difference possible under LOCA	III	4
C 02	Bubbler condenser thermodynamic behaviour	II	4
C 03	Containment leak rates	II	4
C 04	Maximum pressure differences on walls between compartments of hermetic boxes	II	4

Ident.	Name of the safety findings	Cat.	State
C 05	Peak pressure in containment and activation of sub-atmospheric pressure after blowdown	I	4
<i>IH</i>	<i>INTERNAL HAZARDS</i>		
IH 01	Systematic fire hazards analysis	II	4
IH 02	Fire prevention	III	4
IH 03	Fire detection and extinguishing	II	3
IH 04	Mitigation of fire effects	II	3
IH 05	Systematic flooding analysis	I	4
IH 06	Turbine missiles	I	4
IH 07	Internal hazards due to high energy pipe breaks	III	3
IH 08	Heavy load drop	I	4
<i>EH</i>	<i>EXTERNAL HAZARDS</i>		
EH 01	Seismic design	III	3
EH 02	Analyses of plant specific natural external conditions	I	4
EH 03	Man induced external events	II	4
<i>AA</i>	<i>ACCIDENT ANALYSIS</i>		
AA 01	Scope and methodology of accident analysis	II	4
AA 02	QA of plant data used in accident analysis	I	4
AA 03	Computer code and plant model validation	II	4
AA 04	Availability of accident analysis result for supporting plant operation	I	4
AA 05	Main steamline break accident analysis	I	4
AA 06	Overcooling transients related to pressurized thermal shock	II	4
AA 07	Steam generator collector rupture analysis	II	4
AA 08	Accidents under low power and shutdown (LPS) conditions	II	4
AA 09	Severe accidents	I	4
AA 10	Probabilistic safety assessment (PSA)	I	4
AA 11	Boron dilution accidents	I	4
AA 12	Spent fuel cask drop accidents	I	4
AA 13	ATWS	I	4
AA 14	Total loss of electrical power	I	4
AA 15	Total loss of heat sink	I	4

**Safety issues solution status for the NPPs with VVER-1000
at the Temelín NPP**

Ident.	Name of the safety findings	Cat.	State
<i>G</i>	<i>GENERAL</i>		
G 01	Classification of components	II	4
G 02	Qualification of equipment	III	3
G 03	Reliability analysis of safety class 1 and 2 systems	II	4
<i>RC</i>	<i>CORE</i>		
RC 01	Prevention of inadvertent boron dilution	II	4
RC 02	Control rod insertion reliability/Fuel assembly deformation	III	4
RC 03	Subcriticality monitoring during reactor shutdown conditions	II	4
<i>CI</i>	<i>COMPONENT INTEGRITY</i>		
CI 01	RPV embrittlement and its monitoring	III	4
CI 02	Non-destructive testing	III	3
CI 03	Primary pipe whip restraints	II	4
CI 04	Steam generator collector integrity	III	4
CI 05	Steam generator tube integrity	II	4
CI 06	Steam and feedwater piping integrity	III	4
<i>S</i>	<i>SYSTEMS</i>		
S 01	Primary circuit cold overpressure protection	II	4
S 02	Mitigation of a steam generator primary collector break	II	4
S 03	Reactor coolant pump seal cooling system	II	4
S 04	Pressurizer safety and relief valves qualification for water flow	II	4
S 05	ECCS sump screen blocking	III	4
S 06	ECCS water storage tank and suction line integrity	II	4
S 07	ECCS heat exchanger integrity	II	4
S 08	Power operated valves on the ECCS injection lines	I	4
S 09	Steam generator safety and relief valves qualification for water flow	III	4
S 10	Steam generator safety valves performance at low pressure	II	4
S 11	Steam generator level control valves	I	4

S 12	Emergency feedwater make-up procedures	I	4
S 13	Cold emergency feedwater supply to SG	I	4
S 14	Ventilation system of control rooms	II	4
S 15	Hydrogen removal system	II	4

IDENT.	NAME OF THE SAFETY FINDINGS	CAT.	STATE
<i>I&C</i>	<i>INSTRUMENTATION AND CONTROL</i>		
I&C 01	I&C reliability	II	4
I&C 02	Safety system actuation design	I	4
I&C 03	Automatic reactor protection for power distribution and DNB	I	4
I&C 04	Human engineering of control rooms	II	4
I&C 05	Control and monitoring of power distributions in load follow mode	II	4
I&C 06	Condition monitoring for the mechanical equipment	I	4
I&C 07	Primary circuit diagnostic systems	II	4
I&C 08	Reactor vessel head leak monitoring system	III	4
I&C 09	Accident monitoring instrumentation	II	4
I&C 10	Technical support center	II	4
I&C 11	Water chemistry control and monitoring equipment (primary and secondary)	I	4
<i>EL</i>	<i>ELECTRICAL POWER</i>		
El 01	Off-site power supply via startup transformers	I	4
El 02	Diesel generators reliability	I	4
El 03	Protection signals for emergency diesel generators	I	4
El 04	On-site power supply for incident and accident management	II	4
El 05	Emergency battery discharge time	III	4
El 06	Ground faults in DC circuits	I	4
<i>CONT</i>	<i>CONTAINMENT</i>		
Cont 01	Containment by-pass	II	4
<i>IH</i>	<i>INTERNAL HAZARDS</i>		
IH 01	Systematic fire hazards analysis	II	4
IH 02	Fire prevention	III	4
IH 03	Fire detection and extinguishing	II	4
IH 04	Mitigation of fire effects	II	4
IH 05	Systematic flooding analysis	I	4
IH 06	Protection against flood for emergency electric power distribution boards	II	4
IH 07	Protection against the dynamic effects of main steam and feedwater line breaks	II	4
IH 08	Polar crane interlocking	II	4

<i>EH</i>	<i>EXTERNAL HAZARDS</i>		
EH 01	Seismic design	II	4
EH 02	Analyses of plant specific natural external conditions	I	4
EH 03	Man induced external events	II	4
<i>AA</i>	<i>ACCIDENT ANALYSIS</i>		
AA 01	Scope and methodology of accident analysis	II	4
AA 02	QA of plant data used in accident analysis	I	4
AA 03	Computer code and plant model validation	I	4
AA 04	Availability of accident analysis result for supporting plant operation	I	4
AA 05	Main steam line break accident analysis	I	4
AA 06	Overcooling transients related to pressurized thermal shock	II	4
AA 07	Steam generator collector rupture analysis	II	4
AA 08	Accidents under low power and shutdown (LPS) conditions	II	4
AA 09	Severe accidents	I	4
AA 10	Probabilistic safety assessment (PSA)	I	4
AA 11	Boron dilution accidents	I	4
AA 12	Spent fuel cask drop accidents	I	4
AA 13	Anticipated transients without scram (ATWS)	II	4
AA 14	Total loss of electrical power	II	4
AA 15	Total loss of heat sink	II	4

Ranking of issues:

I Issues reflect a departure from recognized international practices. It may be appropriate to address them as a part of actions to resolve higher priority issues.

II Issues are of safety concern. Defence in depth is degraded. Action is required to resolve the issue.

III Issues are of high safety concern. Defence in depth is insufficient. Immediate corrective action is necessary. Interim measures might also be necessary.

IV Issues are of the highest safety concern. Defence in depth is unacceptable. Immediate action is required to overcome the issue. Compensation measures have to be established until the safety problems are resolved.

State:

- 1 – not yet decided
- 2 – project preparation
- 3 – project implementation
- 4 - solved

ANNEX 3 IAEA and WANO Missions

No IAEA missions took place in the period from the last revision of the National Report at nuclear power plants in the Czech Republic. However, the WANO missions were invited to both power plants (Temelín NPP and Dukovany NPP).

The WANO mission will take place in June 2007 at Dukovany NPP; however, no information is available for the time being.

- 1. WANO Peer Review mission (Temelín NPP, November 28 – December 10, 2004)**

- 2. Follow-up WPR mission (Temelín NPP, December 4 – 8, 2006)**

- 3. WANO Peer Review mission (Dukovany NPP, June 2 – 15, 2007)**

1. WANO Peer Review mission (Temelín NPP)

The WANO Peer Review is partner verification. Within this verification, teams of experts delegated by other member organizations to WANO evaluate the safety of nuclear power plants and the level of their operation. These evaluations are voluntary and they are conducted at power plant's own request. The team draws up a report on the results of its evaluation, which is made available to the power plant under evaluation. The power plant decides on the way of elimination of possible deficiencies.

A WANO team, comprised of experienced nuclear professionals from all four WANO regions, conducted a peer review at the Temelin Nuclear Power Plant in December 2004. The purpose of the review was to determine strengths and areas in which improvements could be made, and to support the Temelin NPP in this improvement process. Information was assembled from discussions, interviews, observations of station activities, and from reviews of documentation.

The Temelin NPP has volunteered to be reviewed by a team of 14 peers representing 12 nuclear plants and organizations from 9 countries.

WANO-MC recognizes that many activities and practices performed by Temelin NPP are routinely done well. A fraction of these are identified as strengths and good practices, primarily those that are done exceptionally well or that need to be brought to the attention of other utilities for emulation.

The following strengths and good practices are especially noteworthy:

1. The station has a document which describes the organizational changes being implemented within the company. This document is supplemented by a safety justification report that analyses the effect of every significant change to be performed.
2. Almost all working places of the shift staff of the NPP (excluded MCR) use the electronic log books in PC which are accessible for other personnel of NPP in the plant intranet.
3. Contractors' loan tools from tools store and are held accountable for their return. If the tool is not returned within the correct timescale or in poor condition the contractor is penalised for this. All equipment within this store was of good quality and condition, items such as small screwdrivers were separately identified and everything was traceable.
4. Temelin NPP has in use the Plant Life Managing System, which covers at the moment most important safety related components like reactor pressure vessel, steam generators, pressurizer, main circulating pumps, primary loops, primary circuit purification system etc. They are going to extend that kind of monitoring also to main steam lines, turbines and generators.
5. Two types of electronic forms of radiation protection work permits: standard RWP (expected individual effective dose below 1mSv) and special RWP (individual effective doses higher than 1 mSv) are used in Temelin NPP. Issuing of RWP is connected to PASSPORT program and database of radiation situation parameters (dose rate and surface contamination of proposed working place).
6. Plant has a system for collecting and processing internal and external experiences from operation and maintenance area for using them during pre-job briefings and preparatory phases of operational and maintenance activities in the plant.

Areas for improvement also have been identified during the review. The areas for improvement are intended to assist the Temelin Nuclear Power Plant in ongoing efforts to improve all aspects of its nuclear programs.

2. Follow-up WANO Peer Review mission (Temelín NPP)

A WANO team, comprised of experienced nuclear professionals from WANO Moscow and Paris regions, conducted a follow-up peer review at the Temelin Nuclear Power Plant in Czech Republic. The purpose of the review was to review progress in addressing areas for improvement identified in the December 2004 Temelin WANO Peer Review. Information was assembled from discussions, interviews, observations of station activities, and from reviews of documentation. The WANO follow-up peer review team examined station organization and administration, maintenance, engineering support, chemistry, fire protection.

The Temelin NPP has volunteered to be reviewed by a team of 5 peers representing 5 nuclear plants and companies from 5 countries. The review focused on determining the effectiveness of corrective actions taken in response to the 13 areas for improvement identified in December 2004.

The following results were noted:

Six areas for improvement are considered complete; satisfactory progress has been made. Seven areas for improvement are not fully complete; however, satisfactory progress is being made and should continue. The plant has done a lot of work to solve the problems, and evidences have been found that the objectives will be reached, with a visible deadline.

Although the mission was focused on checking previous areas for improvement, there was identified one Good practice: The applied software TiPoM is a very effective tool for tracking and storing information generated during the design review process.



**Production Division
Dukovany NPP site**

**Equipment Renovation Program
Dukovany NPP
MORAVA**

Procedural Report

**ČEZ, a. s. - Production Division
April 2007**

Background

The drafting of the "*Back-fitting of Dukovany Nuclear Power Plant*" program, the main goal of which was to increase the level of nuclear safety, was already started during the commissioning of the individual units in the Dukovany NPP. The initial design of the Back-fitting was created in 1990 and in 1991 preparation and implementation of the individual activities was started. In the present time all major measures from this program are already implemented. A series of further activities, the aim of which was equipment renovation, was implemented also outside the "Back-fitting" program.

Since the beginning of the nineties the verification in-depth commenced to check the safety level of nuclear power plants constructed based on Russian design, and the efforts to put them out of operation increased in intensity. Regarding these trends, it became obvious that it would be necessary to perform a complex evaluation of the real situation in the Dukovany NPP. A series of analyses and supporting programs was carried out in the frame of international activities and within the Czech Republic. Assessment of the Dukovany NPP was performed both by own experts from the Dukovany NPP and by independent (mainly foreign) experts. For instance experts from the International Atomic Energy Agency (IAEA), experts from nuclear power plants in operation from different countries, experts from the regulatory bodies (Czech and foreign), experts from the manufacturers of nuclear power plants equipment, etc. were involved in the assessment.

Concept of the **Equipment Renovation Program**, which was later named **MORAVA** (**MO**dernization - **Re**construction - **Anal**yses - **VA**lidation), was based on an extensive technical assessment of the Dukovany NPP (technical audit), the goal of which was to evaluate the actual situation of the Dukovany NPP and to propose a list of necessary modifications, which would form a basis for the equipment reconstruction in the next period of time.

The Dukovany NPP audit was split in two parts:

A) **Internal audit**, carried out by teams of about 100 Dukovany NPP employees with the support of external organizations (ÚJV ŘEŽ, 3E Praha and others), evaluated the equipment from five viewpoints:

1. Equipment reliability and its impact on nuclear safety
2. Failure rate of the equipment and its impact on the NPP availability (impact on the production outages)
3. Equipment requirements for maintenance
4. Residual lifetime of the equipment and spare parts status
5. Further impacts, not included in the above (radiation protection, fire protection etc.)

B) **External audit** – within the PHARE project, the ENAC consortium has performed an independent assessment of the technical security of the Dukovany NPP from the viewpoint of international standards and nuclear safety principles.

This step has represented the first verification of the proposed scope of modifications in the Dukovany NPP.

IAEA mission aimed at assessing approach of the Dukovany NPP to the solution of the so-called Safety issues (described by IAEA for VVER 440/213 within the off-budget program (publication IAEA-EBP-WWER-03).

To assess the level of operation many international missions were organized since 1989 (see below).

Main milestones and program starting points

The main milestones for the determination and specification of Equipment Renovation Program and its control, performed both by own efforts or using international support are listed below:

- 1990 – Drafting of the "Initial design of the so-called Back-fitting", i.e. modernization based on the resolution of the government of the ČSSR No. 309 (November 20, 1986) with the main goal to increase nuclear safety;
- 1991 – Creation of an Engineering Services Center in ČEZ-Dukovany NPP;
- 1991 – Commencement of activities included in the Back-fitting program;
- 1991 – Assessment of the conclusions in the so-called "Green Paper" (safety evaluation of the NORD NPP in the former GDR – Dukovany NPP team);
- 1992 – Common activities of the VVER 440/V213 units operators (list of safety improvements, Dukovany NPP representatives, members of the VVER 440/213 club);
- 1994-95 Internal technical audit (Dukovany NPP working teams, support from ÚJV ŘEŽ);
- 1995 – External technical safety audit (ENAC consortium – PHARE program);
- 1995 – Safety Report, updated after 10 years of operation (Škoda Praha);
- 1995 – Probabilistic Safety Assessment (Dukovany NPP team and ÚJV ŘEŽ, further living PSA);
- 1996 – Finalization of the Back-fitting program (most of the activities were carried out, the remaining ones were included into the Equipment renovation program);
- 1996 – Triangular agreement on cooperation and technical information exchange among Dukovany NPP, Bohunice NPP, and Mochovce NPP (exchange of information about modernization measures);
- 1996-99 Composition and validation of the Emergency Operating Procedures (EOPs – created by the Westinghouse company) – analyses conclusions resulted in recommendation for modifications;
- 1997 – Evaluation of the conclusions of technical evaluations and missions;
- 1998 – Drafting of the Equipment Renovation Program documentation (Dukovany NPP team and ÚJV ŘEŽ, EGP Praha);
- 1999-2000 – Implementation of the Preliminary Feasibility Study (Dukovany NPP team and EGP Praha);
- 2001 – Organizational change in ČEZ-Dukovany NPP in the area of modifications control (creation of the technical engineering center and transfer of the investments preparation and implementation to the Maintenance and Repairs Department);
- 2004 – Establishment of the Nuclear Power Plants Division (common organizational structure for Dukovany NPP as well as for Temelín NPP).

SÚJB requirements from the Decision for units 1 to 4 and other supporting evaluations were further inputs to the Equipment Renovation Program.

Since 1990, supporting PHARE (EU) programs are also used.

To verify the Dukovany NPP approach, independent evaluations have been used (the main ones being):

1989 – OSART (IAEA) mission

1991 – RE-OSART (IAEA) mission
1993 – ASSET (IAEA) mission
1995 – IAEA mission focused on the Safety issues area
1996 – ASSET (IAEA) mission
1996 – "Insurance" (March & McLeuman, Gradmann & Holler)
1997 – "Insurance" (Czech Nuclear Pool)
1997 – Peer Review (WANO, INPO)
1998 – IPERS (IAEA - PSA-1)
1999 – WPR, Follow-up (WANO), Verification of fulfillment of the WPR conclusion from 1997
2000 – "Insurance" (Czech Nuclear Pool), Continuous inspection on insurance risks
2001 – ISO 14000 (Det Norske Veritas), Certification audit of Dukovany NPP environmental impact
2001 – OSART (IAEA) mission, Operational safety verification
2002 – ISO 14001 (Det Norske Veritas) Re-certification audit of Dukovany NPP environmental impact
Morava program was as well verify through exchange of information within WANO in the following year.

Course of program

The Equipment Renovation Program, called MORAVA, linked up to the modernization activities designed and implemented in the frame of the Back-fitting Program.

The Equipment Renovation Program documentation was approved during the ČEZ-Dukovany NPP technical council meeting in March 1998. The program was later named MORAVA.

Significance and purpose of the work on the Equipment renovation program have two main aspects – safety and economical (in summary – to reach the safety level accepted in the EU, to extend the license till 2025 while conserving the competitiveness).

Many safety relevant activities were already carried out. Majority of the proposed measures based on IAEA safety findings, which were assessed also in the frame of the EU (Atomic Questions Group), are already resolved. All this induced a significant decrease of the probability of core meltdown. A concerted effort of the Czech Republic, Slovak Republic and Hungary helped to resolve common recommendation of the AQG for the VBK.

In the present time the main effort is directed to conclusion of the solution of the Category III safety findings (the highest priority given for VVER440/213) and the intermediate category II.

Renovation of the Instrumentation and Control (I&C) system is one of the most significant activities within the MORAVA program. The renovation of the I&C system in the Dukovany NPP is performed from Unit to Unit till 2010.

Dukovany NPP Equipment renovation program control

Dukovany NPP Equipment renovation is composed of a set of partial constructions or modules. The part A – thesis specifying, among other things, the Dukovany NPP approach in the area of the Equipment renovation program preparation and implementation, was also part of the Equipment renovation program documentation (dated March 1998). Stepwise implementation of the individual Equipment renovation program parts or modules using

standard procedure in accordance with the Dukovany NPP legislation in a way not to influence the refueling outages duration and not to modify the basic safety philosophy of the project was one of the basic principles. The selected way of project implementation has proven to be the most suitable also regarding the optimal use of financial resources of ČEZ, a. s. without the necessity to plan great yearly peaks.

Completion of the modernization activities of the Dukovany NPP Equipment renovation program (MOP) is scheduled for 2010.

The whole set of activities was assessed as to feasibility, including the complex economic analysis. The evaluation results confirm the correctness of the selected approach.

CONCLUSION

The Dukovany NPP represents cheap, reliable, and highly safe and environmentally friendly source of electric power in the Czech Republic. It is a Czech nuclear power plant as its design was completed in the Czech Republic, and it was constructed and manufactured there based on design background from the former Soviet Union. The parameters of the Dukovany NPP are fully comparable with the nuclear power plants operated in the Western countries (including the European Union countries) and will be further improved during the further plant development. It is also fully comparable with nuclear power plants operated in the countries in Western Europe as to safety; and is fully competitive as to economic effectiveness.

The conclusions of the WENRA evaluation report "Nuclear safety in the EC candidate countries" (10/2000) states: "It is expected that upon the complete implementation of the modernization program, the Dukovany NPP will reach the safety level fully comparable with the nuclear power plants of the same operational age operated in Western Europe".

The last evaluation of the European Union conducted at the beginning of 2001 by the AQQ (Atomic Questions Group) and the WPNS (Working Party on Nuclear Safety) shows that the major safety deviations, which they had indicated, are correctly identified and solved in MOP with the highest priority (see Annex 1). The conclusions of the OSART mission carried out at the end of 2001 confirmed high safety level.

The Equipment renovation program MORAVA as well as its modernization part were thus determined to be in accordance with the European safety practice, and the preparation and implementation is advancing in a correct, controlled direction. Program Morava is being followed by SALTO program allowing further economical and safe operation of Dukovany NPP.

MORAVA program scheduled part of the modernization until 2010

Modification of equipment in PoE + 14,7m Replacement of electric motor drives of important valves	Completion in 2005
Restraints against surging medium and flying objects	Completion in 2005
Emergency aftercooling	Completion in 2008
Instrumentation and control system renovation	M 1. Safety systems - 2010 M 2. Process computer systems - 2010
Spent fuel intermediate storage facility extension (MSVP)	Completion of the civil part in 2006
Change in the 110 kV reserve power supply connection	Completion in 2005
Technical and Support Center	1. Part – 2005 2. Part – 2006
Activities resulting from the leakage before break project Increase of KO resistance against vibrations Circulation pipe whip restraints	Completion in 2005 Completion in 2006
Main and emergency control rooms habitability securing - ventilation systems	Completion in 2006
Diagnostic systems – modernization	Completion in 2006

ANNEX 5 List of Legislative Regulations Dealing with Nuclear Energy and Ionizing Radiation and Related Documents

ATOMIC ACT AND RELATED IMPLEMENTING DECREES

Act No. 18/1997 Coll., on peaceful utilisation of nuclear energy and ionising radiation (**the Atomic Act**) and on Amendments and Alterations to Some Acts as amended by Act No. 83/1998 Coll., Act No. 71/2000 Coll., Act No. 132/2000 Coll., Act No. 13/2002 Coll., Act No. 310/2002 Coll., Act No. 320/2002 Coll., Act. No. 279/2003 Coll., Act No. 186/2004 Coll., Act. No. 1/2005 Coll., Act No. 253/2005 Coll., Act No. 413/2005 Coll., Act No. 186/2006 Coll. and Act. No. 342/2006 Coll.

- **SÚJB Decree No. 214/1997 Coll.**, on quality assurance in activities related to the utilization of nuclear energy and in radiation practices, and laying down criteria for the assignment and categorization of classified equipment into safety classes,
- **SÚJB Decree No. 215/1997 Coll.**, on criteria for siting of nuclear installations and very significant ionizing radiation sources,
- **SÚJB Decree No. 106/1998 Coll.**, on nuclear safety and radiation protection assurance during commissioning and operation of nuclear facilities,
- **SÚJB Decree No. 195/1999 Coll.**, on basic design criteria for nuclear installations with respect to nuclear safety radiation protection and emergency preparedness,
- **SÚJB Decree No. 309/2005 Coll.**, on assurance of technical safety of selected equipment,
- **SÚJB Decree No. 185/2003 Coll.**, on decommissioning of nuclear installation or workplaces of category III or IV,
- **SÚJB Decree No. 146/1997 Coll.**, specifying activities directly affecting nuclear safety and activities especially important from radiation protection viewpoint, requirements on qualification and personnel training, on methods to be used for verification of special professional competency and for issue authorisations to selected personnel, and the form of documentation to be approved for the licensing of expert training of selected personnel, as amended by the SÚJB Decree No. 315/2002 Coll.,
- **SÚJB Decree No. 307/2002 Coll.**, on radiation protection, as amended by the SÚJB Decree No. 499/2005 Coll.,
- **SÚJB Decree No. 318/2002 Coll.**, on details of emergency preparedness of nuclear facilities and workplaces with ionising radiation sources and on requirements on the content of on-site emergency plan and emergency rule, as amended by the Decree of the SÚJB No. 2/2004 Coll.,
- **SÚJB Decree No. 319/2002 Coll.**, on function and organization of the National Radiation Monitoring Network, as amended by the Decree of the SÚJB No. 27/2006 Coll.,
- **SÚJB Decree No. 193/2005 Coll.**, sets the list of theoretical and practical areas forming the education and preparation content required in the Czech Republic for the performance of regulated activities belonging to the competence of SÚJB,

- **Government Order No. 11/1999 Coll.**, on emergency planning zone.
- **Ministry of Finance Decree No. 107/2003 Coll.**, on the share of the Regional Offices in the allocation of subsidies, intended to cover risks resulting from the presence of radon and its daughter products in the internal atmosphere of constructions and in the waters for public supplies, and in adoption of related measures,
- **SÚJB Decree No. 419/2002 Coll.**, on personal radiation passports,
- **Government Order No. 416/2002 Coll.**, laying down the amount of levy and the manner paying thereof by the authors of radioactive waste on the nuclear account and the annual amount of the contribution for the municipalities and the rules for granting thereof
- **Ministry of Industry and Trade Decree No. 360/2002 Coll.**, laying down the manner of creation of reserve for withdrawal of nuclear facility or working place of category III or IV,
- **SÚJB Decree No. 318/2002 Coll.**, on details of emergency preparedness of nuclear facilities and workplaces with ionising radiation sources and on requirements on the content of on-site emergency plan and emergency rule, as amended by the Decree of the SÚJB No. 2/2004 Coll.,
- **SÚJB Decree No. 317/2002 Coll.**, on type approval of packaging assemblies for transport, storage and disposal of nuclear materials and radioactive substances, on type approval of ionizing radiation sources and on transport of nuclear materials and specified radioactive substances ("on type approval and transport"),
- **SÚJB Decree No. 179/2002 Coll.**, laying down a list of selected items and dual use items in nuclear sector,
- **SÚJB Decree No. 324/1999 Coll.**, on limits of concentrations and amount of nuclear material for which nuclear liability requirements does not apply,
- **SÚJB Decree No. 145/1997 Coll.**, on accounting for and control of nuclear materials and their detailed specification, as amended by the Decree of the SÚJB No. 316/2002 Coll.,
- **SÚJB Decree No. 144/1997 Coll.**, on physical protection of nuclear materials and nuclear installations and nuclear facilities and their classification,
- **Ministerial non-registered regulation MPO 9/97** (issued by the Ministry of the Industry and Trade under No. 9/1997), defining the statute of Administration of Radioactive Waste Repositories.

MULTILATERAL INTERNATIONAL TREATIES AND TREATIES WITH IAEA

Part of the valid Czech legislation in the given area includes the following international treaties signed by the Czech Republic (or the former Czechoslovak Socialist Republic and later the Czech and Slovak Federal Republic):

- The Convention on the Physical Protection of Nuclear Materials (in Vienna on October 26, 1979, communication of the MZV No. 27/2007 Coll.),
- The Convention on Early Notification of a Nuclear Accident (in Vienna on September 26, 1986, communication of the MZV No. 116/1996 Coll.),
- The Convention on Assistance in the Case of a Nuclear or Radiation Accident (in Vienna on September 26, 1986, communication of the MZV No. 115/1998 Coll.),

- Nuclear Safety Convention (in Vienna on June 17, 1994, communication of the MZV No. 67/1998 Coll.),
- Vienna Convention on Civil Liability for Nuclear Damage (in Vienna on May 21, 1963, ratified, communication of the MZV No. 133/1994 Coll.),
- The Joint Protocol relating to the Application of the Vienna and Paris Conventions on Liability for Nuclear Damage (in Vienna in 1988, ratified, communication of the MZV No. 133/1994 Coll.),
- The Protocol on Amendment to the Vienna Convention on Civil Liability for Nuclear Damage (in Vienna on September 12, 1997, signed by the Czech Republic on June 18, 1998, however has not been ratified as yet),
- The Comprehensive Nuclear Test Ban Treaty (has not become valid as yet, the Czech Republic's Government Order No. 535/1996),
- Joint Convention on the Safety of Spent Fuel Management and on the Safety of Radiological Waste Management (in Vienna on September 5, 1997, UV No. 593/1997, ratified on March 26, 1999),
- The Treaty on the Non-Proliferation of Nuclear Weapons (NPT) (Decree by the MZV No. 61/1974 Coll., of March 29, 1974),
- The Convention on Supplementary Compensation for Nuclear Damage (in Vienna on September 12, 1997, the Government Order No. 97/1998, signed by the Czech Republic, however has not been ratified),
- The Convention on Environmental Impact Assessment in a Transboundary Context (Espoo, February 25, 1991, ratified on February 26, 1991, Decree by the MZV No. 91/2001 Coll.),
- The Convention on Korean Energetics Development Organization (KEDO) – letter of the MZV on acceptance of the Agreement of March 9, 1995 and of the supplemental Protocol of 1997 by the Czech Republic dated January 27, 1999; the Czech Republic became a member on February 9, 1999,
- The Agreement between the Czech Republic and the International Atomic Energy Agency on Safeguards, based on the Treaty on Non-proliferation of Nuclear Weapons (in Vienna on September 18, 1996, through communication of the MZV No. 68/1998 Coll.),
- The Supplemental Protocol to the Agreement between the Czech Republic and the International Atomic Energy Agency on Safeguards, based on the Treaty on Non-proliferation of Nuclear Weapons (in Vienna on September 28, 1999, through communication of the MZV No. 74/2003 Coll.),
- Adapted supplemental Agreement on Technical Assistance provided by the International Atomic Energy Agency to Government of the Czech and Slovak Federal Republic (in Vienna on September 20, 1990, No. 509/1990 Coll.).

SELECTED ACTS CONCERNING THE SÚJB

- *Act No. 281/2002 Coll.*, on some measures with regard to prohibition of bacteriology (biological) and toxin weapon, as amended,
- *Act No. 106/1999 Coll.*, on free access to information, as amended,
- *Act No. 123/1998 Coll.*, on the right to information on environment, as amended,

- *Act No. 594/2004 Coll.*, implementing the regime of the European Communities to control the export of dual use goods and technologies, as amended,
- *Act No. 19/1997 Coll.*, on some measures related to prohibition of chemical weapons, as amended,
- *Act No. 100/2001 Coll.*, on assessment of impact on the environment,
- *Act No. 111/1994 Coll.*, on road traffic, as amended,
- *Act No. 552/1991 Coll.*, on state inspection, as amended,
- *Act No. 183/2006 Coll.*, on town and country planning and building code (Building Act), as amended by Act. No. 68/2007 Coll.,
- *Act No. 500/200 Coll.*, on administrative procedure (Rules of Administration), as amended by Act No. 413/2005 Coll.

EMERGENCY LEGISLATION

- *Constitutional Act No. 110/1998 Coll.*, on security of the Czech Republic, as amended.
- *Ministry of Interior Decree No. 328/2001 Coll.*, on certain details of providing of integrated emergency system, as amended,
- *Act No. 239/2000 Coll.*, on integral rescue system and on the amendment of some laws, as amended,
- *Act No. 240/2000 Coll.*, on crisis management and on the amendment of some laws, as amended,
- *Act. No. 59/2006 Coll.*, on severe accident prevention, as amended,
- *Act No. 412/2005 Coll.*, on classified information protection and on security competence, as amended.

ANNEX 6 Evaluation of the Safety Performance Indicators Set

As compared with the previous National Report of the Czech Republic 2004, the Evaluation of the Safety Performance Indicators Set of the National Report of the Czech Republic 2007 can be found on SÚJB website http://www.sujb.cz/?c_id=104.

ANNEX 7 References

- [1-1] Technical Notes of the Operational Safety Review Team to Czechoslovakia, Czech Power Works, NPP Dukovany; IAEA, 1989.
- [1-2] Report of the Fulfillment of the OSART Mission Recommendations in the Area of Maintenance; IAEA, 1991.
- [1-3] Report of the OSART mission to the Dukovany NPP, IAEA-TCR-00918, 2003.
- [1-4] ASSET Mission to the Dukovany NPP in Czech Republic; IAEA, 1993.
- [1-5] ASSET Peer Review of the Dukovany NPP Self Assessment of Operational Events Reflecting Safety Performance; IAEA, 1996.
- [1-6] Safety issues and their ranking for WWER- 440 Model 213 Nuclear Power Plants; IAEA, 1996.
- [1-7] A Safety Improvement Review Mission to Dukovany NPP; IAEA, 1996.
- [1-8] Site Safety Review Mission – Final Report; IAEA, 1990.
- [1-9] Pre Operational Safety of Nuclear Installations, Czech Power Works, Temelín NPP – Report to the Government of the Czech and Slovak Federal Republic; IAEA, 1990.
- [1-10] Temelín Design Review Mission – Final report; IAEA, 1990.
- [1-11] Technical Notes of the Pre-Operational Safety Review Team to Czechoslovakia, Czech Power Works, NPP Temelín; IAEA, 1992.
- [1-12] QARAT Mission Report (IAEA-RU-3845 a IAEA-RU-3846); IAEA, 1993.
- [1-13] Report of the Consultant Meeting Design Modifications of Temelín NPP; IAEA, 1994.
- [1-14] Temelín Fire Safety Mission Final Report; IAEA, 1996.
- [1-15] Safety Issues and their Ranking for WWER-1000 Model 320 Nuclear Power Plants; IAEA, 1996.
- [1-16] Report of VVER Safety Issues Resolution at the Temelín NPP; IAEA, 1996.
- [1-17] WANO Peer Review of Temelin Nuclear Power Plant, IAEA, 2004.
- [1-18] WANO Follow-up Peer Review of Temelin Nuclear Power Plant, IAEA, 2006.

- [6-1] BN 01.1 – Guidelines for Personnel Training for the Performance of Working Activities (Functions) at Nuclear Installations in the Czech Republic, SÚJB, 1994.

- [14-1] Standard Technical Specifications – NUREG 0452; US-NRC, 1980.

ANNEX 8 Research Nuclear Installations

This Annex has been elaborated beyond the scope of obligations resulting from the Nuclear Safety Convention. The Annex contains description of the research nuclear installations in the Czech Republic.

The nuclear program in the Czech Republic has been supported since the beginning of its development by the domestic scientific-research base. The main role of this base has been played by the Nuclear Research Institute in Řež (NRI), established in 1955. Significant part of the experimental part of the scientific base is the research reactors.

Pursuant to Act on state-governed surveillance of 1984, the research nuclear installations are subject to similar regulatory regime as the nuclear power plants and other nuclear installations (approval process, presentation of prescribed safety-related documentation – safety reports, Limits and Conditions, etc.), are subject of the inspections carried out by SÚJB, which also verifies qualification and issues authorizations for main control room personnel. This regulatory regime was further strengthened by issuing the Atomic Act in 1997 and its amendment in 2002.

In 2004, the SÚJB issued the Safety Instructions – SÚJB requirements for research installations for assurance of nuclear safety, radiation protection, physical protection and emergency preparedness, which superseded SÚJB Decree No. 9 of 1985. The IAEA recommendations issued in 2003 and constructional and operational experience from research nuclear installations in the Czech Republic and worldwide were used in its preparation.

Since issue of the Act on state supervision in 1984, the research reactors have been subject to the same regulatory regime as the nuclear power plants and other nuclear installations, i.e. same licensing stages and necessity to submit determined safety documentation (safety reports, Limits and Conditions, etc.). The reactors have been subjects of the regulatory inspections carried out by the SÚJB, which also verifies and issues authorizations for main control room personnel. This regulatory regime was further strengthened by issuing the Atomic Act in 1997 and its amendment in 2002.

Operators of all nuclear research installations, in accordance with these documents, perform also internal inspection activities of their safety and regularly inform SÚJB on operational results and abnormal events.

Individual research nuclear installations

LVR-15 Research Reactor in ÚJV Řež a. s.

Construction of the reactor, originally named VVR-S, was commenced in 1955 and the reactor was commissioned on September 24, 1957. Its thermal power was 2 MWt. The reactor served as a multi-purpose research installation for the Czechoslovak nuclear program and the national economy. The reactor was employed to produce radioisotopes, irradiation materials and scientific research in the reactor physics area. Its output was increased to 4 MWt in 1964. Essential reconstruction took place in 1989, when all process equipment including the reactor vessel were replaced. Transition to highly enriched fuel IRT-2M was performed and the output was increased to 8 MWt. In 1994 the maximum allowed output was increased to 10 MWt and the reactor employment was increased by transiting to three-week campaign.

Construction of several experimental loops in the nineties significantly increased the

experimental possibilities of the LVR-15 reactor. These loops simulate conditions in the PWR and BWR reactors and thus allow testing of constructional materials under real conditions. In 1995 the reactor switched to fuel with lower enrichment (36 %).

At the present time, the LVR-15 reactor ranks in Europe among several material reactors with average output. Besides material research (reactor vessel materials irradiation, corrosion tests of primary circuit materials and core internals) and tests of primary circuit water regimes, the reactor is employed to perform neutron activation analysis, to produce and develop new radio-pharmaceutical preparates, to produce radiation-treated silicon for electrotechnical industry, irradiation service and scientific research of material properties on horizontal channels. Since 2000 the reactor is ranked among several workplaces in the world dealing with the neutron capture therapy for brain tumors.

In April 2003 the reactor operator received from SÚJB approval to continue in further operation until the end of 2014.

The INSARR mission on the LVR-15 reactor took place on December 1-5, 2003 and experts from five countries operating research reactors participated therein. The mission stated that "the IAEA recommendations for research reactors safety are observed during the reactor operation, and the reactor is operated in a safe and competent way". The mission further made a statement on active approach of the institute and reactor management to nuclear safety and radiation protection. In conclusion, the mission submitted to the operator a set of recommendations to further improve safety of the LVR-15 reactor operation. Based on these recommendations the operator prepared time schedule for their implementation.

The Follow-up INSARR mission (December 6 – 9, 2005) verified the fulfillment of proposed recommendations and concluded that the overwhelming majority of proposed recommendations were met showing thus high safety culture of reactor personnel and institute management.

In 2006, a program of controlled ageing of selected reactor components was initiated and aimed at extending the operating time of the research reactor after 2018.

The LVR-15 reactor has been incorporated in the report CSNI/NEA/OECD – Support facilities for existing and advanced reactor (SFEAR) among significant experimental equipment for current and future NPP.

Since 2005, the Czech Republic has actively participated in the Russian Research Reactor Fuel Return (RRFR) program within the joint initiative of the Russian Federation and United States of America, and in the Reduction of Enrichment in Research and Test Reactors (RERTR) program for reduction of enrichment in research reactors below 20%.

The preparation for the transport of spent nuclear fuel from the reactor from the beginning of its operation for reprocessing to the Russian Federation is currently culminating. The transport is scheduled for second half-year 2007 and it shall be executed in storage packages VPVR/M manufactured by ŠKODA Plzeň.

LR-0 Critical Assembly in ÚJV Řež a. s.

The LR-0 critical assembly was built by reconstructing the heavy-water TR-0 critical assembly. Heavy-water critical assembly TR-0 with zero output was constructed in NRI Řež and most of its equipment was manufactured in the former Czechoslovakia. The reactor was employed to perform research on reactor core of the A-1 (HWGCR) nuclear power plant in Jaslovské Bohunice. The reactor was put into operation on June 21, 1972 and operated until

1979.

In connection with transition of the Czechoslovak nuclear program to NPPs with VVER pressurized water reactors, the TR-0 was reconstructed to LR-0 experimental light water reactor with zero output. Physical start-up of the LR-0 reactor took place on December 19, 1982 and the reactor was put into permanent operation in 1983. Maximum allowed output of the reactor is 5 kWt and it is operated using shortened fuel assemblies of VVER-1000 and VVER-440 reactors.

The reactor is employed to perform research on core physics (it has variable pitch of a reactor lattice), storage racks and to simulate neutron fields in the power reactors. The reactor may be regulated using absorption rods, boric acid and by moderator level.

Within experimental work for MSR type reactors (GEN IV), it is designed to innovate the control equipment of the LR-0 reactor, which will be digital. The innovation will be carried out in the period 2007-2008, and based on its approval by the regulatory body and successful implementation, the SÚJB shall be requested to grant an operation permit once the current permit expires – i.e. end of 2009.

VR-1 Training Reactor at ČVUT - FJFI

The VR-1 training reactor was commissioned on December 3, 1990 at ČVUT-FJFI (Czech Technical University – Nuclear Engineering Faculty). The reactor used the IRT-M fuel and all its equipment was manufactured in the former Czechoslovakia. The reactor is employed in the training process of university students, in the scientific activities and for needs to prepare specialists of the Czech nuclear power. The training reactor participates in international cooperation (TEMPUS, ENEN and NEPTUNO programs) and it has close contacts with similar training reactors in UK, Netherlands and Austria. The reactor has an approval for its operation until 2007.

In October 2005, the 36% enriched fuel (HEU) on VR-1 reactor was exchanged for 20% enriched fuel (LEU). The VR-1 reactor became thus the first reactor with IRT type Russian fuel, for which such exchange was executed within the RERTR program.

ŠR-0 Research Assembly in Plzeň

In 1971 the ŠR-0 light water assembly with zero output was put into operation at ŠKODA Plzeň. Original allowed output of the system of 100 Wt was increased in 1975 to 2 kWt. This reactor was put out of operation in 1992.

Conclusion

All nuclear research installations operated in the Czech Republic are in compliance with the IAEA recommendations – Safety requirements of research reactor a Code of conduct on the safety of research reactors.